

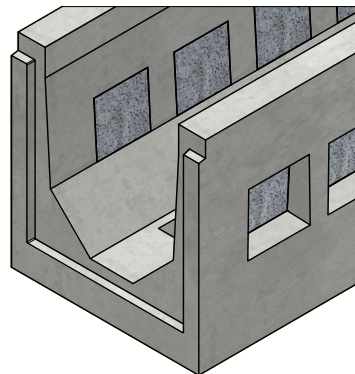

DELTA-UM CANIVEAU X SERIE B000 TYPE I

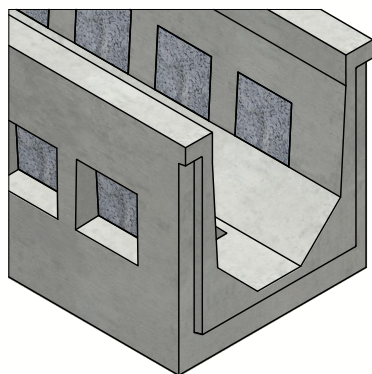

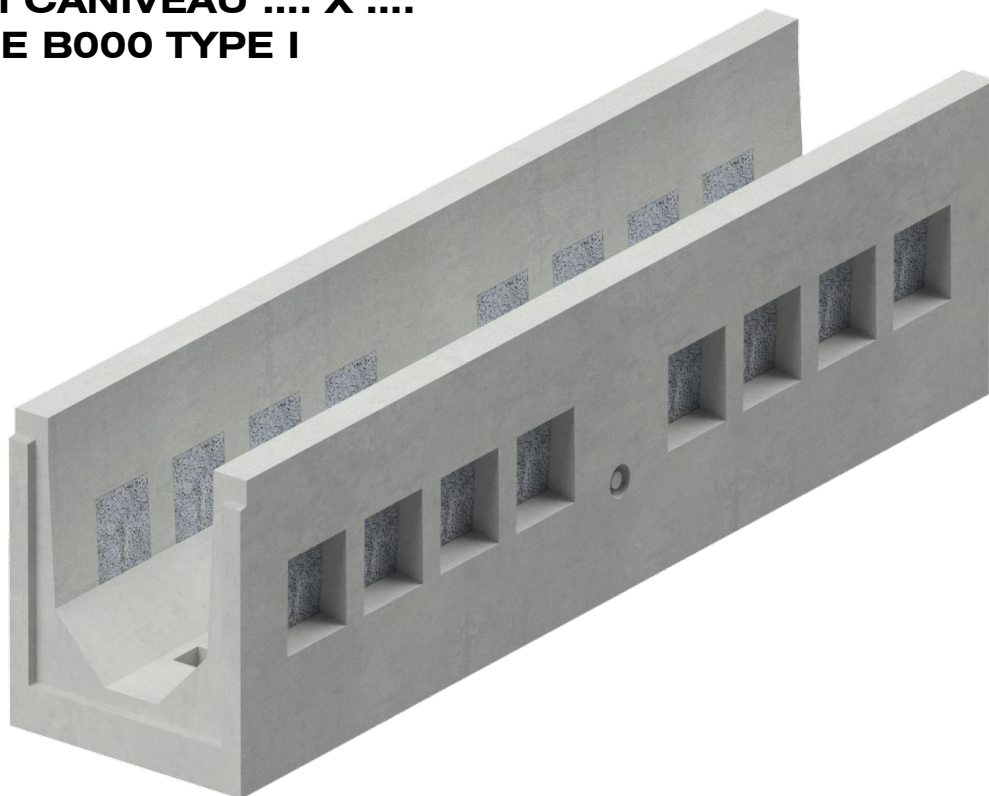

| | |
|--------------------------------|-------------------------------|
| Classe de charge: | min. 270L/m |
| Surface d'absorption: | 2400 cm ² /m |
| Sol d'absorption: | N/A |
| Capacité d'absorption: | min. 600L/m/h |
| Classe de résistance du béton: | C60/75 |
| Classe d'exposition: | XD3-XF4-XC4-XA3 |
| Longueur de travail: | 3000 mm |
| Emboîtement: | Raccord mâle-femelle |
| Manutention: | 2 x DH |
| Prescriptions de pose: | Selon prescriptions fabricant |
| Norme: | PTV108 |
| Poids: | - |



Projet : **Fiche technique**

N° art. : DELTA-UM-IPxxxxxxxxxB000

N° rev. : 0 Date rev. : 7/12/2021

**DELTA-UM CANIVEAU X
SÉRIE B000 TYPE I**

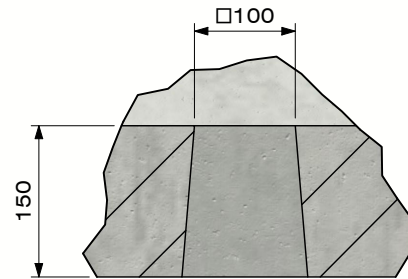
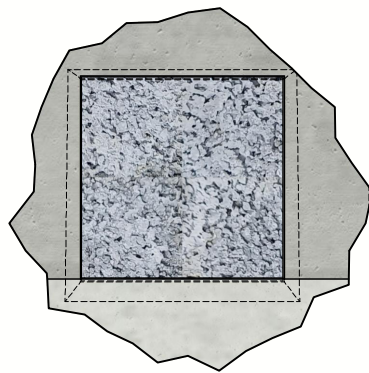
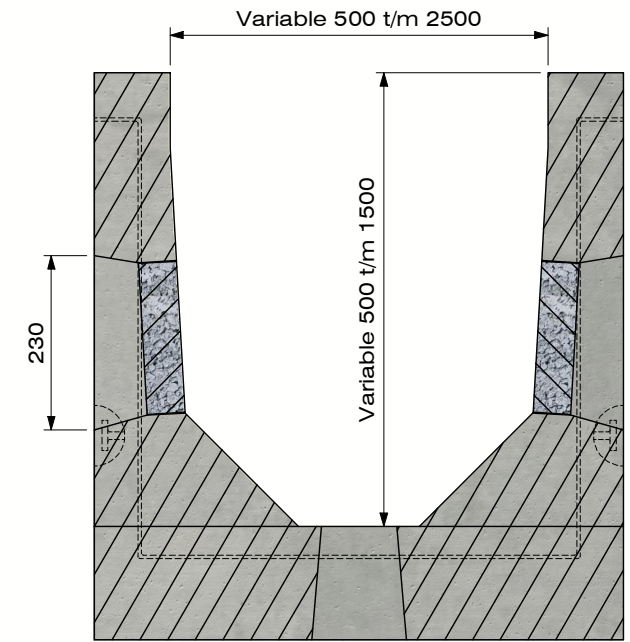
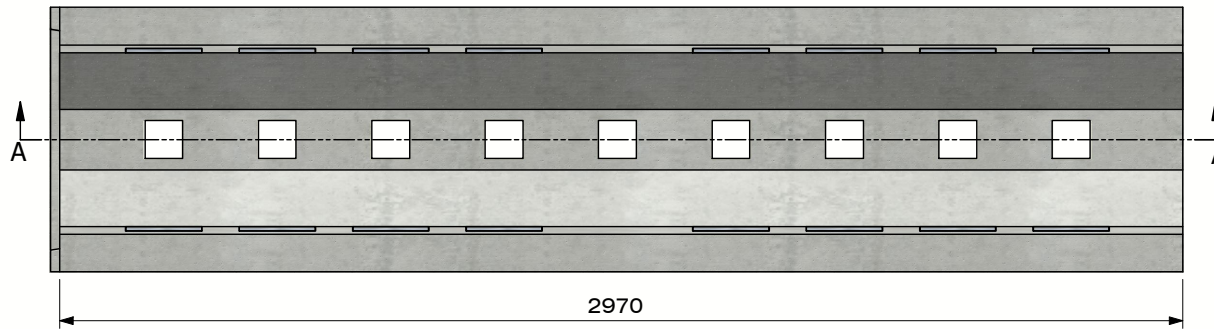
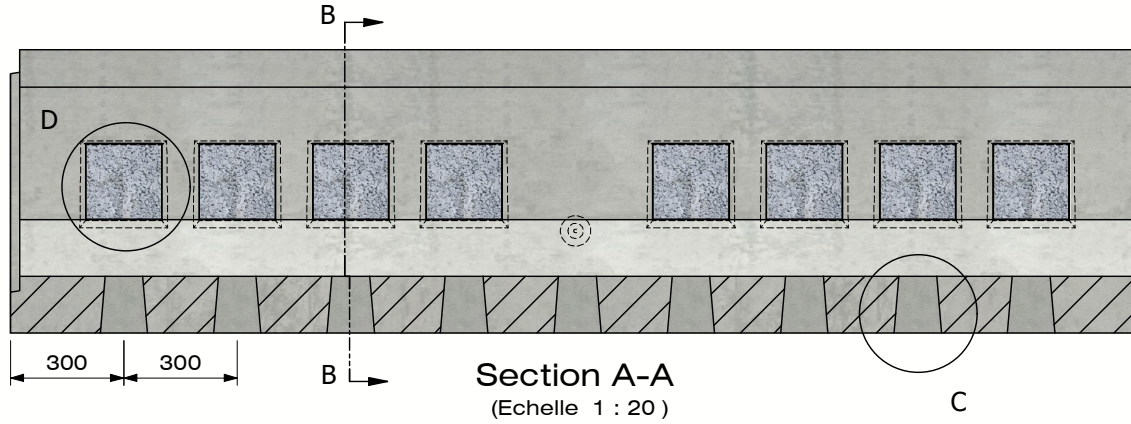

| LARGEUR | | HAUTEUR |
|---------|--|---------|
| 500 | <i>N'importe quelle largeur peut être combinée avec n'importe quelle hauteur</i> | 500 |
| 600 | | 600 |
| 700 | | 700 |
| 800 | | 800 |
| 900 | | 900 |
| 1000 | 1000 | |
| 1200 | 1100 | |
| 1500 | 1200 | |
| 2000 | 1300 | |
| 2500 | 1400 | |
| | | 1500 |

DELTA U

Projet : **Fiche technique**

N° art. : DELTA-UM-IPxxxxxxxxxB000

N° rev. : 0 Date rev. : 7/12/2021

BENOR 