

Sluitplaat DELTA-U 500-450-G025 GROEF

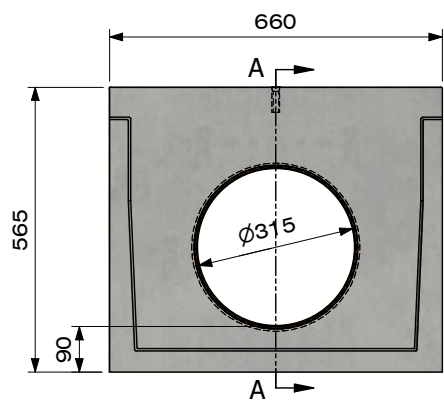

SPO

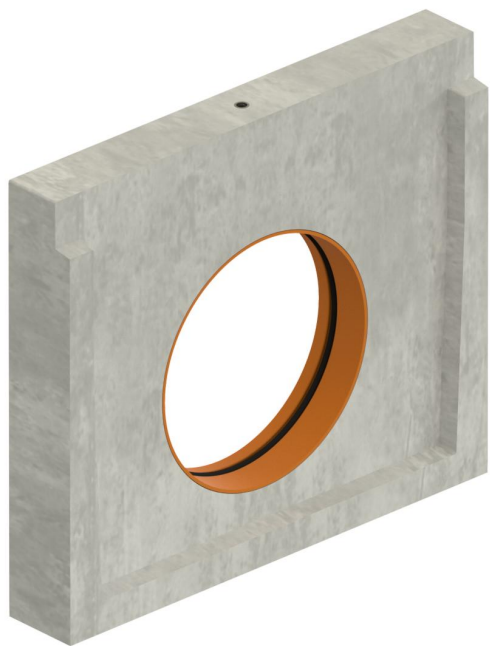

Sectie A-A
(Schaal 1 : 15)

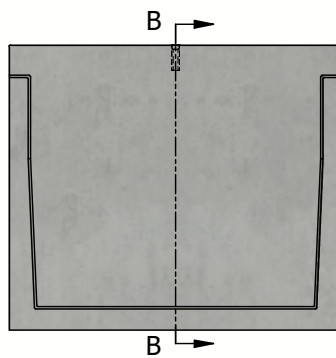

SPB

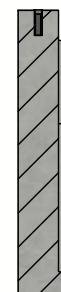

Sectie B-B
(Schaal 1 : 15)

Belastingsklasse:	N/A
Instroomoppervlak cm ² / lm:	N/A
Sleufprofieltype:	N/A
Randen:	beton
Sectie stroomprofiel cm ² :	N/A
Betonsterkteklasse:	C60/75
Omgevingsklassen:	XD3-XF4-XC4-XA3
Duurzaamheid:	W+R
Werkende lengte:	100
Helling stroomprofiel:	N/A
Helling bovenvlak:	N/A
Verbinding:	T/G
Hijsvoorziening:	1 x M12 schroefanker
Plaatsingsvoorschrift:	volgens opgave producent
Normering:	conform EN1433
Gewicht:	62 Kg

DELTA U

B.P.M.N. SA
Chaussée de namur 2 , B-5150 Floriffoux

Project :	Accessoires & supplementen	
Art. nr. :	DELTA-U500450G025SP-GROEF	
REV. nr. :	0	REV. Datum : 19/01/2021



BENOR

