

DELTA-O caniveau à fente DN300 - serie SS - Type I

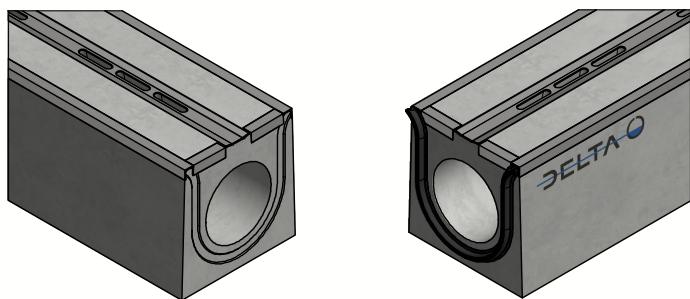

Liaison pression par joint
EPDM

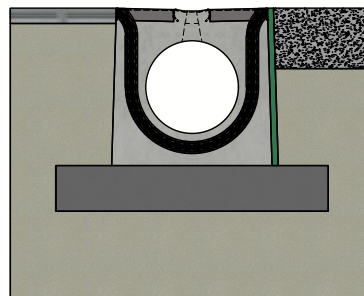

Principe type I
(Consulter les prescriptions de pose)







Classe de charge:	D400-E600-F900 cf EN1433
Surface d'absorption cm ² / m:	286
Fente type:	Acier
Bords:	Acier
Section d'écoulement cm ² :	726
Classe de résistance du béton:	C60/75
Classe d'exposition:	XD3-XF4-XC4-XA3
Durabilité:	W+R
Longueur de travail:	4000
Pente d'écoulement:	0
Pente surface supérieure:	0,01
Emboîtement:	par pression
Manutention:	2x clés de levage
Prescriptions de pose:	selon prescription fabricant
Norme:	conforme EN1433
Poids:	1901 Kg



B.P.M.N. SA
Chaussée de namur 2, B-5150 Floriffoux

Projet :	Fiche technique		
N° art. :	DELTA-O3004000SS		
N° rev. :	0	Date rev. :	11/02/2021

DELTA-O caniveau à fente
DN300 - serie SS - Type I

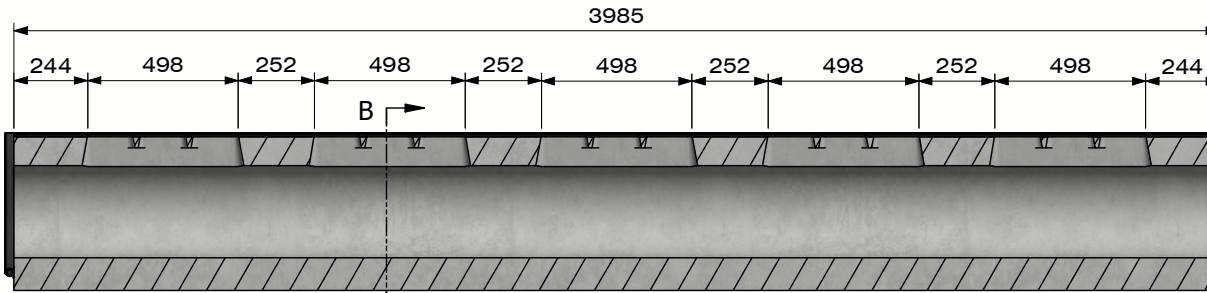

Section A-A
 (Echelle 1 : 25)



Section B-B
 (Echelle 1 : 7.5)

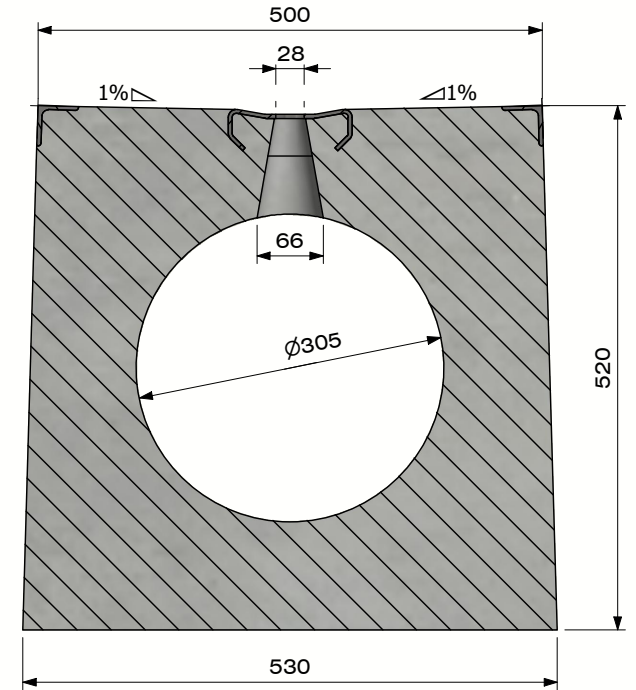

- Option GIR :

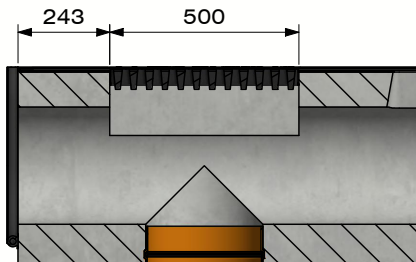

Grille d'inspection intégrée
 - D400-E600-F900
 - Verrouillable
 Option sortie verticale



B.P.M.N. SA
 Chaussée de namur 2, B-5150 Floriffoux

Projet :	Fiche technique		
N° art. :	DELTA-O3004000SS		
N° rev. :	0	Date rev. :	11/02/2021

