

DELTA-O caniveau à fente DN400 - élément de coin 2,5°-7,5°-15°-30° - Type I

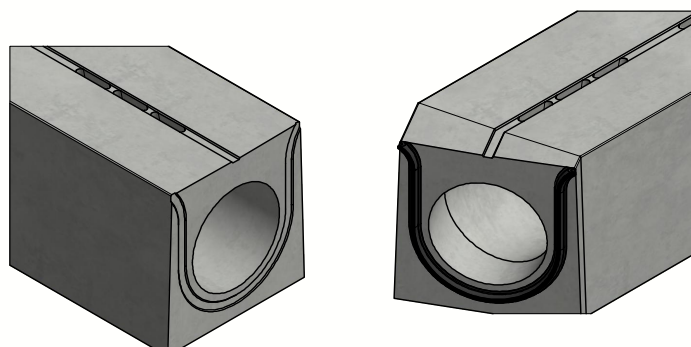

Classe de charge:	D400-E600-F900 cf EN1433
Surface d'absorption cm ² / m:	185
Fente type:	N/A
Bords:	N/A
Section d'écoulement cm ² :	1295
Classe de résistance du béton:	C60/75
Classe d'exposition:	XD3-XF4-XC4-XA3
Durabilité:	W+R
Longueur de travail:	4000
Pente d'écoulement:	0
Pente surface supérieure:	centré 1%
Emboîtement:	par pression
Manutention:	2x clés de levage
Prescriptions de pose:	selon prescription fabricant
Norme:	conform EN1433
Poids:	2604 Kg



Liaison pression par joint
EPDM

Option GIR :

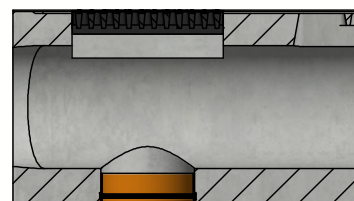





Grille d'inspection intégrée
- D400-E600-F900
- Verrouillable
Option sortie verticale



B.P.M.N. SA
Chaussée de namur 2, B-5150 Floriffoux

Project :	Fiche technique	
Art. nr. :	DELTA-O4004000XX-X_HXXXX	
REV. nr. :	0	REV. Datum : 10/03/2021

**DELTA-O caniveau à fente DN400 -
élément de coin 2,5°-7,5°-15°-30° - Type I**

Pour les séries BB/SB/SS/BS

