

DELTA-T CANIVEAU 400x300 SERIE G060 TYPE I

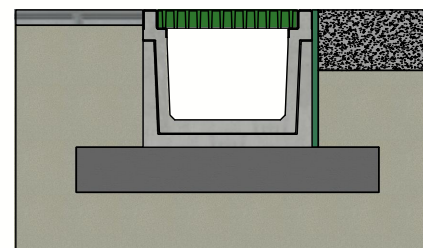
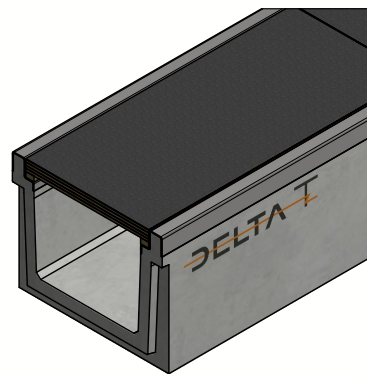
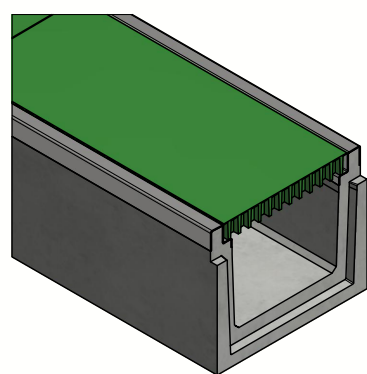
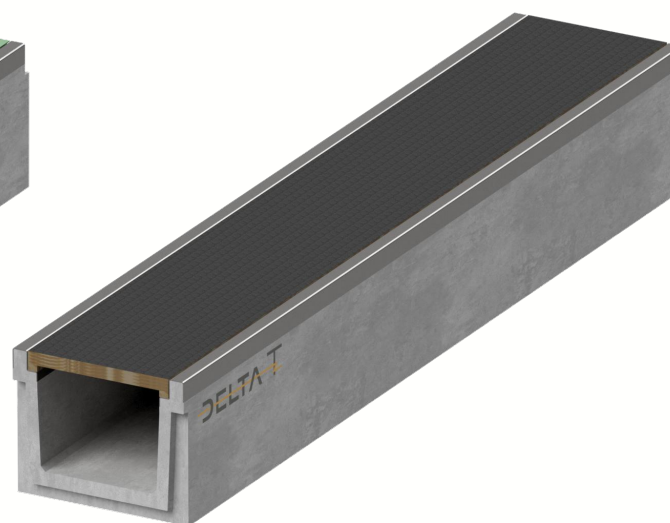
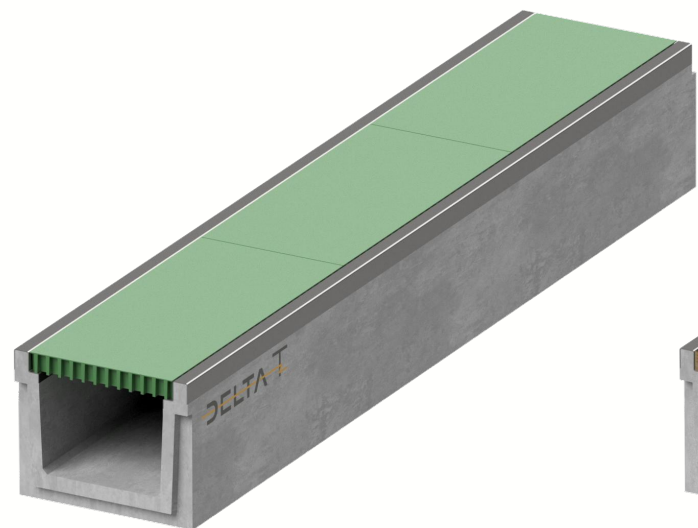

C250: Plastique

B125: Bois de contreplaqué

Principe type I
(Consulter les prescriptions de pose)

Classe de charge:	B125-C250 cf EN1433
Surface d'absorption cm ² / m:	N/A
Fente type:	N/A
Bords:	Acier, galva
Section d'écoulement cm ² :	1200
Classe de résistance du béton:	C60/75
Classe d'exposition:	XD3-XF4-XC4-XA3
Durabilité:	W+R
Longueur de travail:	3000
Pente d'écoulement:	0
Pente surface supérieure:	N/A
Emboîtement:	Raccord mâle-femelle
Manutention:	4 x DH 1,3T
Prescriptions de pose:	selon prescriptions fabricant
Norme:	conforme EN1433
Poids:	909 Kg



B.P.M.N. SA
Chaussée de namur 2 , B-5150 Floriffoux

Projet :	Fiche technique	
N° art. :	DELTA-T4003003000G060	
N° rev. :	0	Date rev. : 8/03/2021



DELTA-T CANIVEAU 400x300 SERIE G060 TYPE I

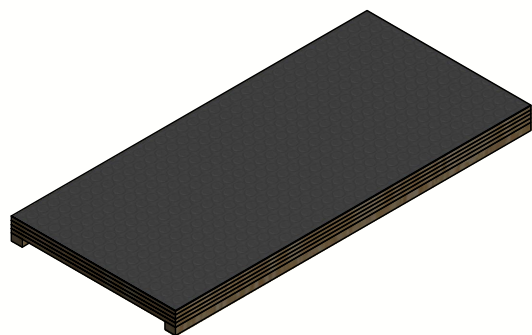
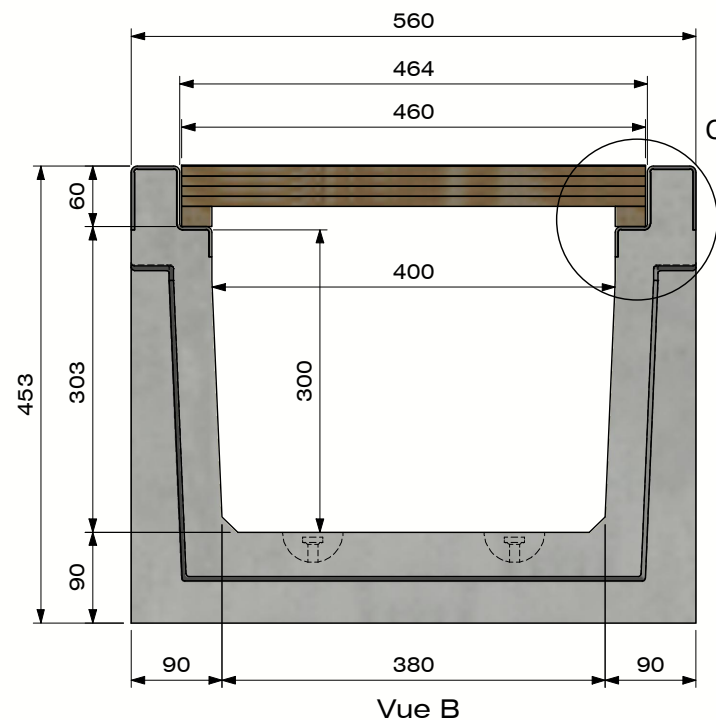
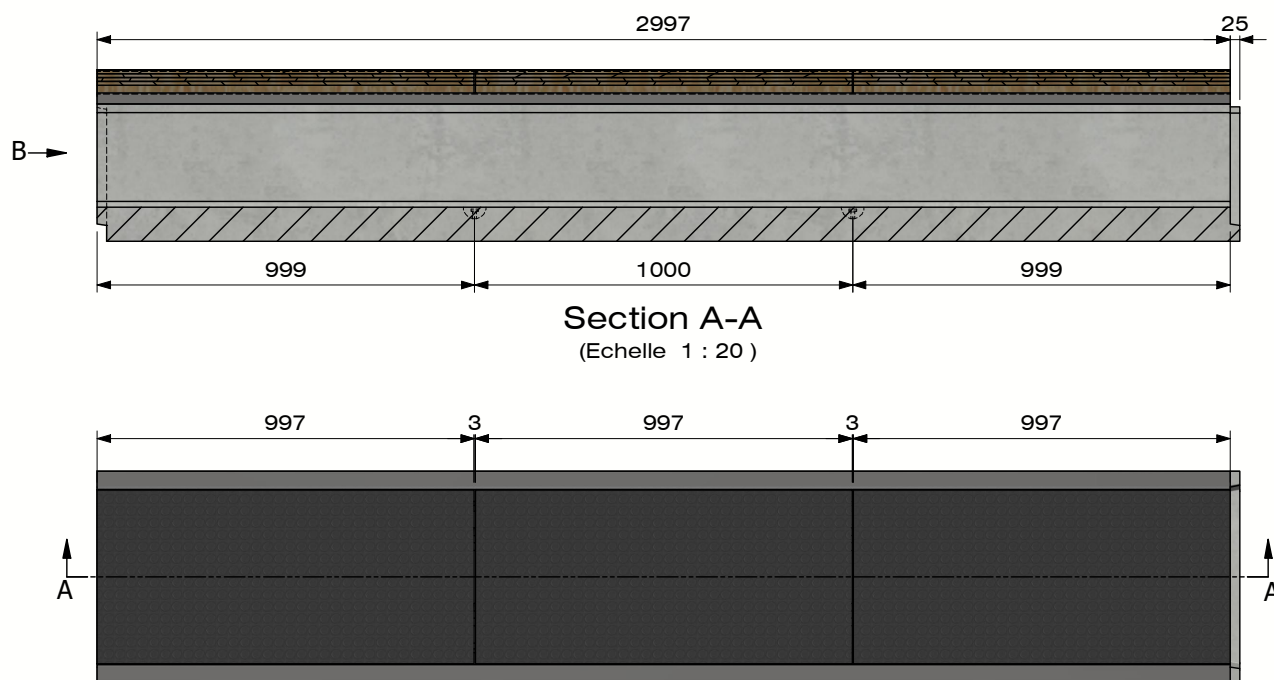

B125: Bois de contreplaqué
DELTA-T600D1000IH060

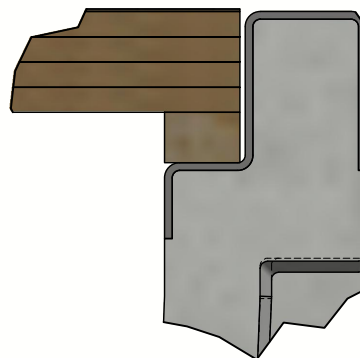



Detail C



B.P.M.N. SA
Chaussée de namur 2 , B-5150 Floriffoux

Projet :	Fiche technique		
N° art. :	DELTA-T4003003000G060		
N° rev. :	0	Date rev. :	8/03/2021

**DELTA-T CANIVEAU 400x300
SERIE G060 TYPE I**

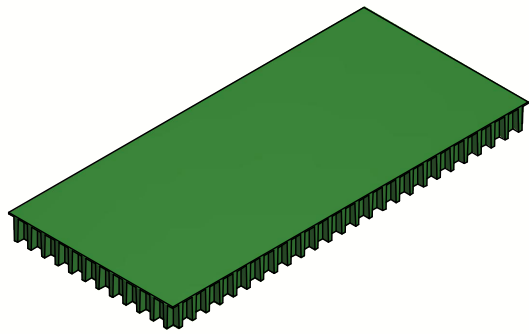
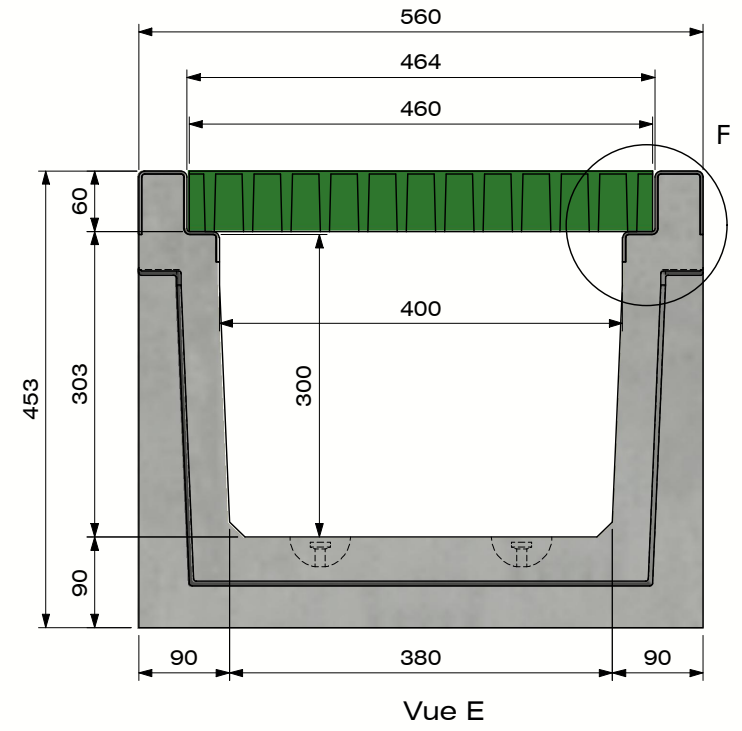
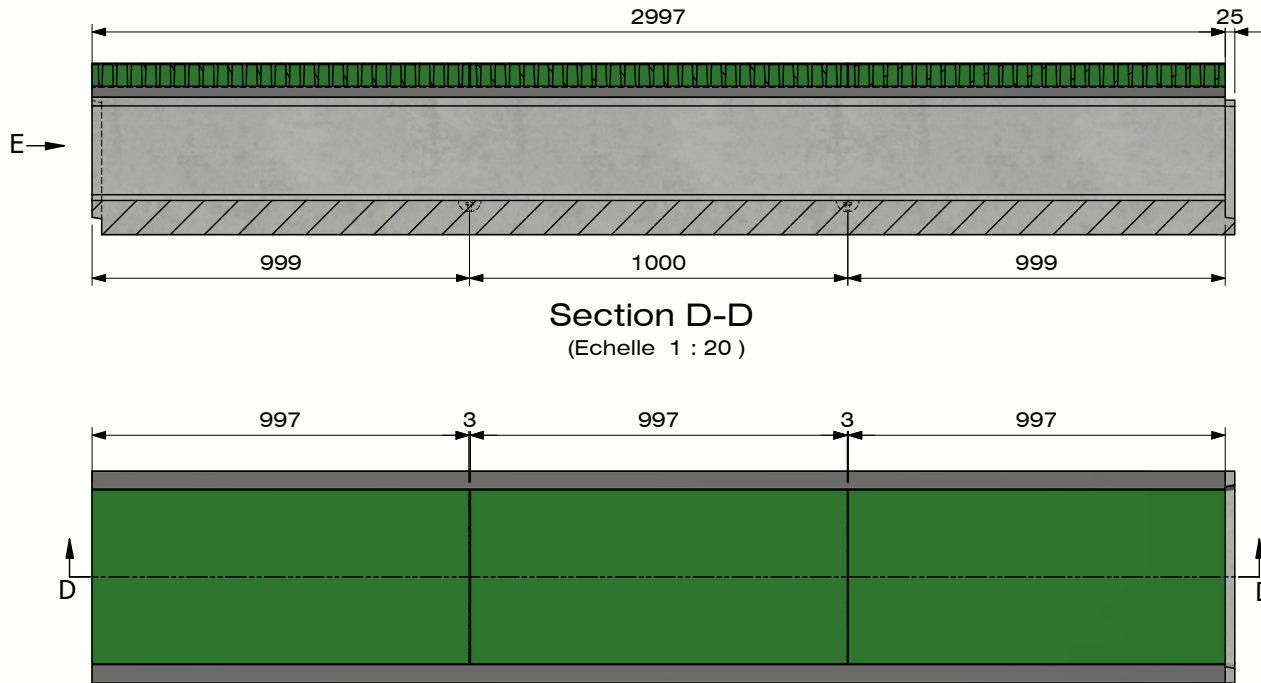

C250: Plastique
DELTA-T600D1000IP060

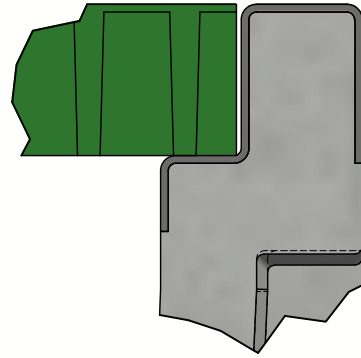

Detail F



B.P.M.N. SA
Chaussée de namur 2 , B-5150 Floriffoux

Projet :	Fiche technique		
N° art. :	DELTA-T4003003000G060		
N° rev. :	0	Date rev. :	8/03/2021

