

Plaque d'about DELTA-T 500-450-G060 femelle

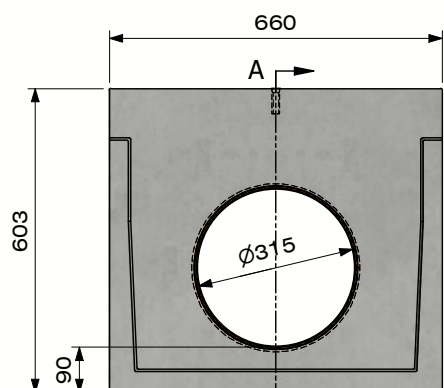

SPO

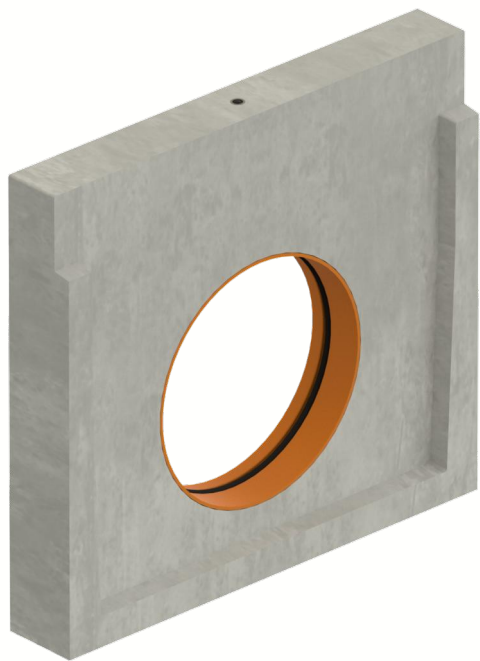
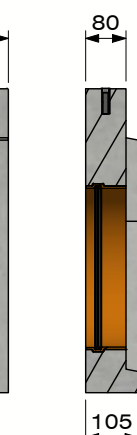

Section A-A
(Echelle 1 : 15)

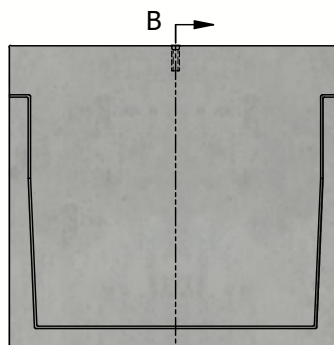

SPB

Section B-B
(Echelle 1 : 15)

Classe de charge:	N/A
Surface d'absorption cm ² / m:	N/A
Fente type:	N/A
Bords:	béton
Section d'écoulement cm ² :	N/A
Classe de résistance du béton:	C60/76
Classe d'exposition:	XD3-XF4-XC4-XA4
Durabilité:	W+R
Longueur de travail:	100
Pente d'écoulement:	N/A
Pente surface supérieure:	N/A
Emboîtement:	Raccord mâle-femelle
Manutention:	1 x ancre à visser M12
Prescriptions de pose:	selon prescriptions fabricant
Norme:	conforme EN1433
Poids:	66 Kg



B.P.M.N. SA
Chaussée de namur 2 , B-5150 Floriffoux

Projet : Accessoires et suppléments	
N° art. : DELTA-T500450G060SP-GROEF	
N° rev. : 0	Date rev. : 18/03/2021

