

# Plaque d'about DELTA-T 500-450-G060 mâle

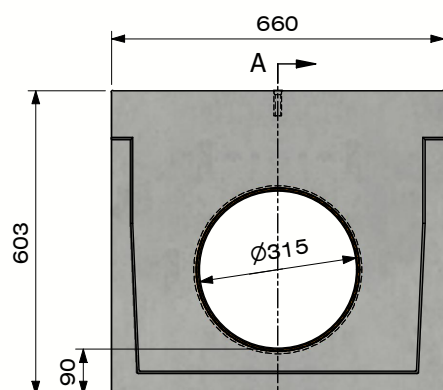

**SPO**

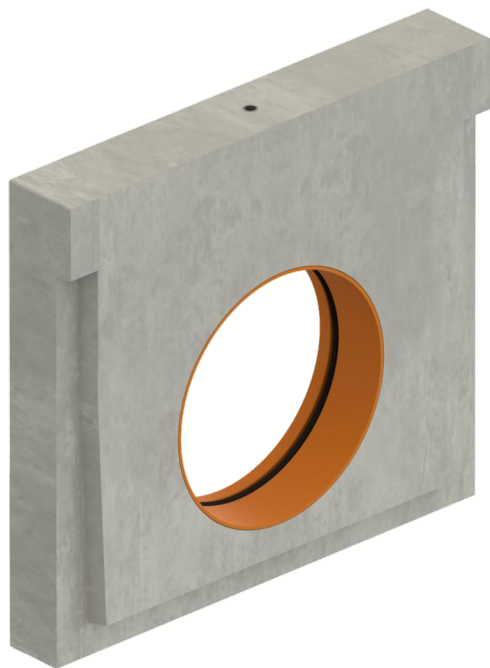

**Section A-A**  
(Echelle 1 : 15)

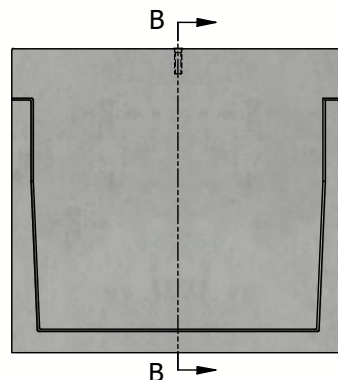

**SPB**

**Section B-B**  
(Echelle 1 : 15)

Classe de charge:	N/A
Surface d'absorption cm <sup>2</sup> / m:	N/A
Fente type:	N/A
Bords:	béton
Section d'écoulement cm <sup>2</sup> :	N/A
Classe de résistance du béton:	C60/76
Classe d'exposition:	XD3-XF4-XC4-XA4
Durabilité:	W+R
Longueur de travail:	100
Pente d'écoulement:	N/A
Pente surface supérieure:	N/A
Emboîtement:	Raccord mâle-femelle
Manutention:	1 x ancre à visser M12
Prescriptions de pose:	selon prescriptions fabricant
Norme:	conforme EN1433
Poids:	77 Kg



**B.P.M.N. SA**  
Chaussée de namur 2 , B-5150 Floriffoux

Projet : <b>Accessoires et suppléments</b>	
N° art. : DELTA-T500450G060SP-TAND	
N° rev. : 0	Date rev. : 18/03/2021

