

DELTA-U CANIVEAU À GRILLE 400x600 SERIE G025 TYPE I

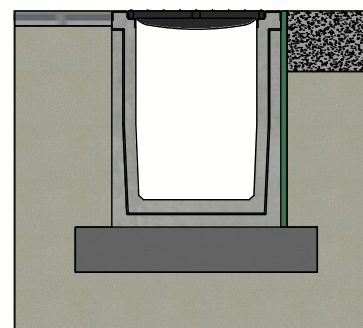

Classe de charge:	D400-F900 cf EN1433
Surface d'absorption cm ² / m:	N/A
Fente type:	N/A
Bords:	Acier
Section d'écoulement cm ² :	2400
Classe de résistance du béton:	C60/75
Classe d'exposition:	XD3-XF4-XC4-XA3
Durabilité:	W+R
Longueur de travail:	3000
Pente d'écoulement:	0
Pente surface supérieure:	N/A
Emboîtement:	Raccord mâle-femelle
Manutention:	4 x DH 1,3T
Prescriptions de pose:	selon prescriptions fabricant
Norme:	conforme EN1433
Poids:	1364 Kg

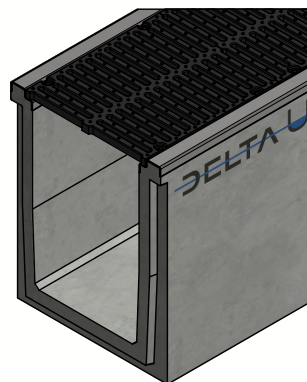
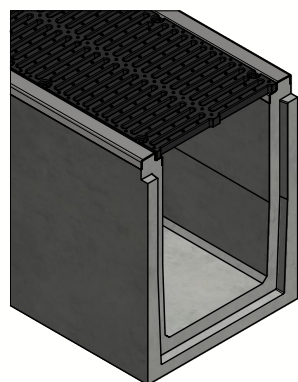

Principe type I
(Consulter les prescriptions de pose)

DELTA U

B.P.M.N. SA
Chaussée de namur 2 , B-5150 Floriffoux

Projet :	Fiche technique	
N° art. :	DELTA-U4006003000G025	
N° rev. :	0	Date rev. : 6/01/2021



DELTA-U CANIVEAU À GRILLE 400x600 SERIE G025 TYPE I

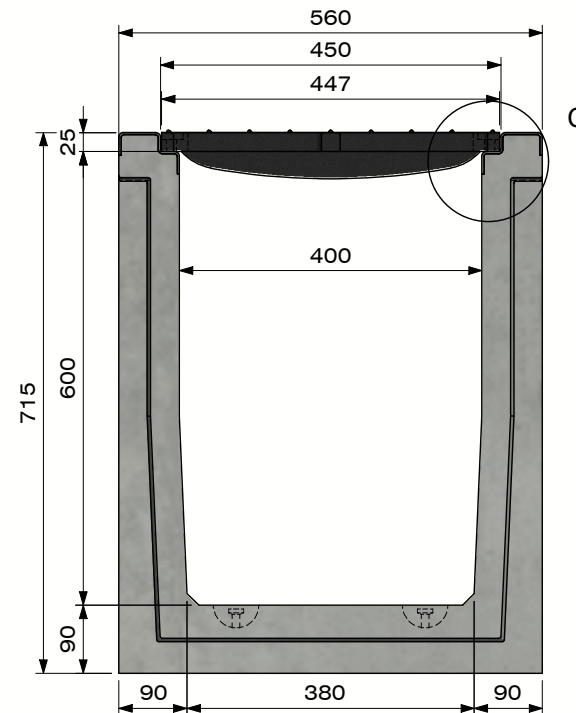
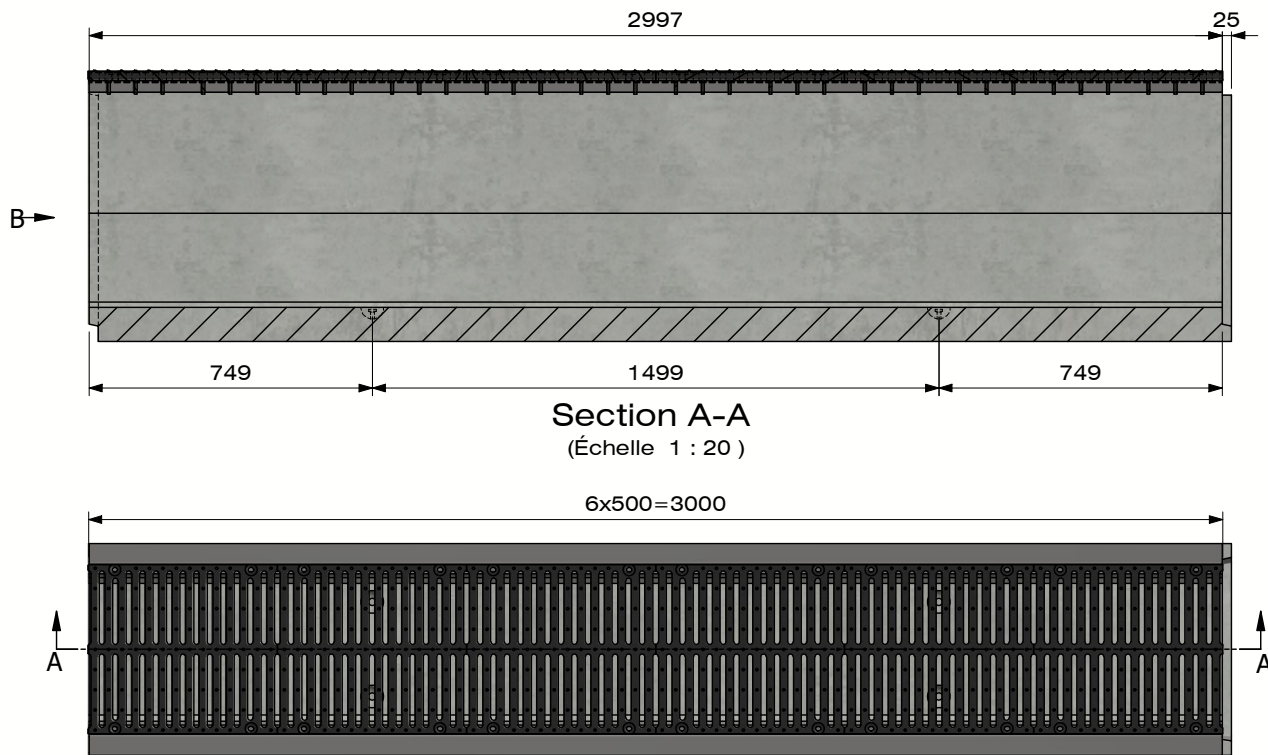

Vue B

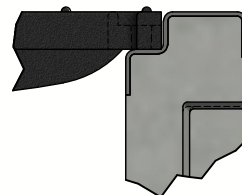

Detail C

D400 : DELTA-U400D500IS025D-DR
F900 : DELTA-U400D500IS025F-DR



B.P.M.N. SA
Chaussée de namur 2 , B-5150 Floriffoux

Projet :	Fiche technique		
N° art. :	DELTA-U4006003000G025		
N° rev. :	0	Date rev. :	6/01/2021

