

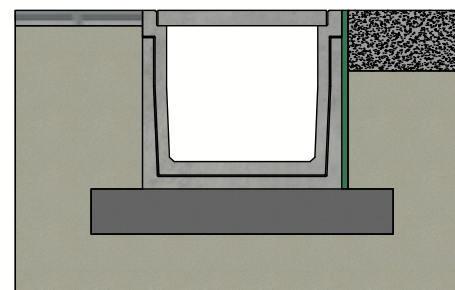

# DELTA-U CANIVEAU 500x450 SERIE B050 TYPE I

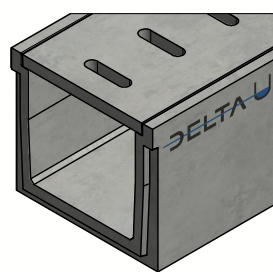

Classe de charge:	A15 cf EN1433
Surface d'absorption cm <sup>2</sup> / m:	N/A
Fente type:	N/A
Bords:	béton
Section d'écoulement cm <sup>2</sup> :	2250
Classe de résistance du béton:	C60/75
Classe d'exposition:	XD3-XF4-XC4-XA3
Durabilité:	W+R
Longueur de travail:	2000
Pente d'écoulement:	0
Pente surface supérieure:	N/A
Emboîtement:	Raccord mâle-femelle
Manutention:	4 x DH 1,3T
Prescriptions de pose:	selon prescriptions fabricant
Norme:	conforme EN1433
Poids:	823 Kg

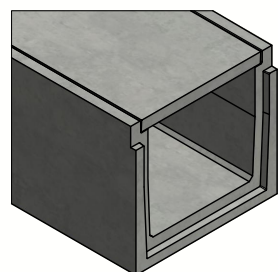



Principe type I  
(Consulter les prescriptions de pose)



B.P.M.N. SA  
Chaussée de namur 2 , B-5150 Floriffoux

Projet :	<b>Fiche technique</b>	
N° art. :	DELTA-U5004502000B050A	
N° rev. :	0	Date rev. : 6/01/2021

# DELTA-U CANIVEAU 500x450 SERIE B050 TYPE I

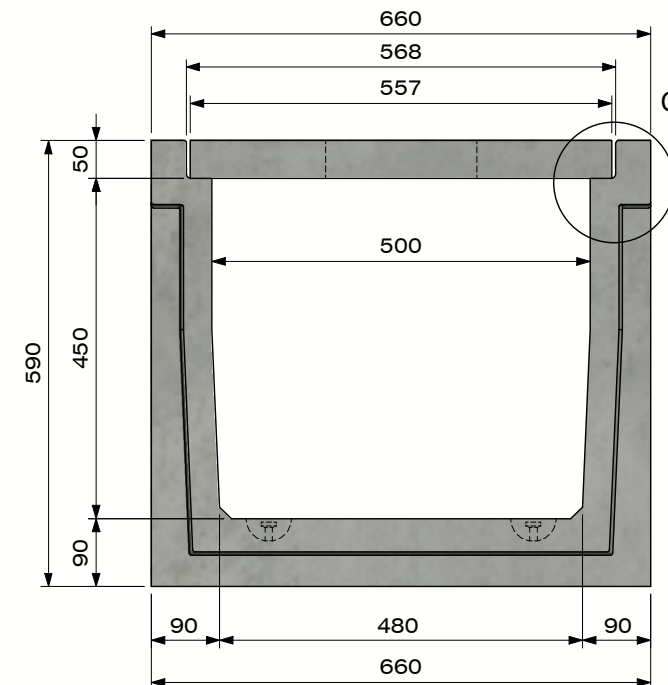
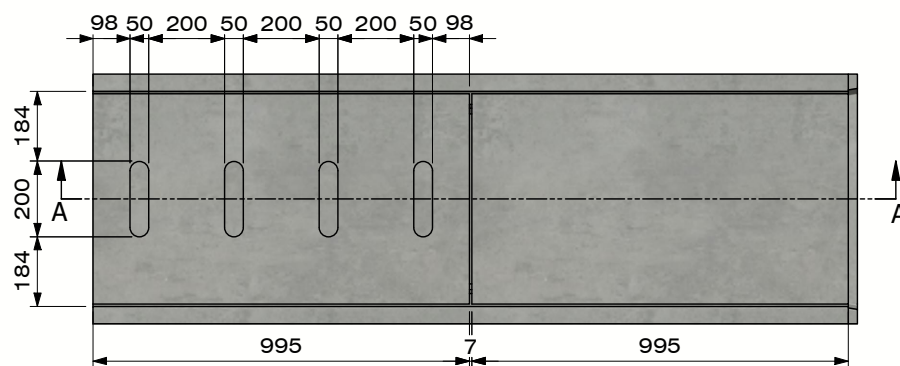
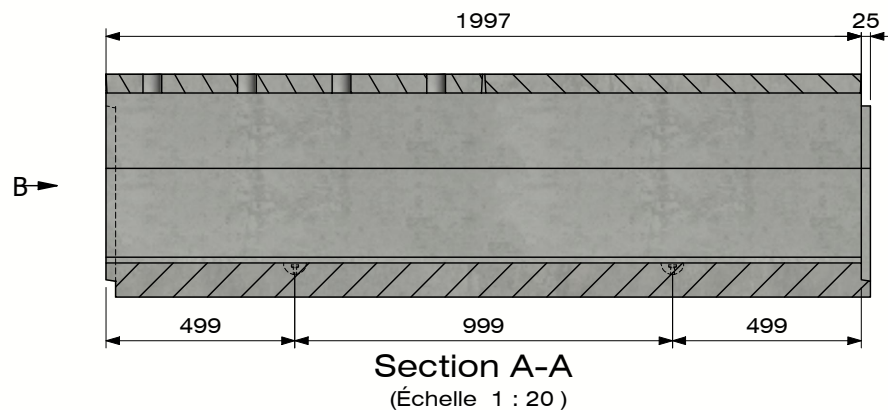

Vue B

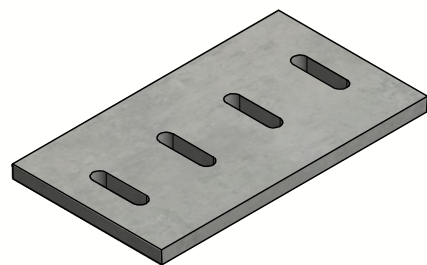

Couvercles avec  
ouvertures

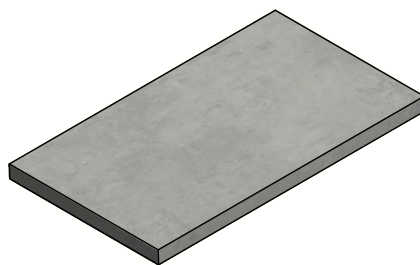

Couvercles sans  
ouvertures

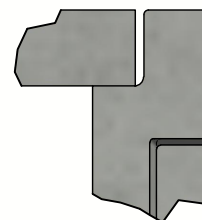

Detail C



B.P.M.N. SA  
Chaussée de namur 2 , B-5150 Floriffoux

Projet :	<b>Fiche technique</b>	
N° art. :	DELTA-U5004502000B050A	
N° rev. :	0	Date rev. : 6/01/2021

