

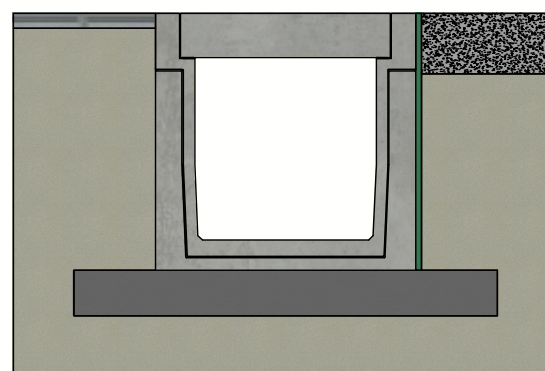

DELTA-U CANIVEAU 600x600 SERIE B150 TYPE I

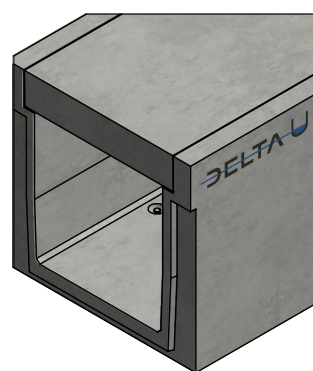

Classe de charge:	D400 cf EN1433
Surface d'absorption cm ² / m:	N/A
Fente type:	N/A
Bords:	béton
Section d'écoulement cm ² :	3600
Classe de résistance du béton:	C60/75
Classe d'exposition:	XD3-XF4-XC4-XA3
Durabilité:	W+R
Longueur de travail:	2000
Pente d'écoulement:	0
Pente surface supérieure:	N/A
Emboîtement:	Raccord mâle-femelle
Manutention:	4 x DH 1,3T
Prescriptions de pose:	selon prescriptions fabricant
Norme:	testé selon EN1433
Poids:	1863 Kg

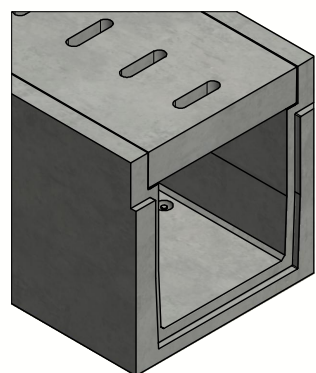



Principe type I
(Consulter les prescriptions de pose)



B.P.M.N. SA
Chaussée de namur 2 , B-5150 Floriffoux

Projet :	Fiche technique	
N° art. :	DELTA-U6006002000B150D	
N° rev. :	0	Date rev. : 6/01/2021

DELTA-U CANIVEAU 600x600 SERIE B150 TYPE I

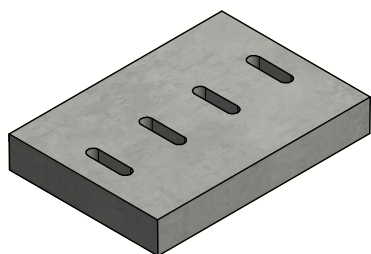
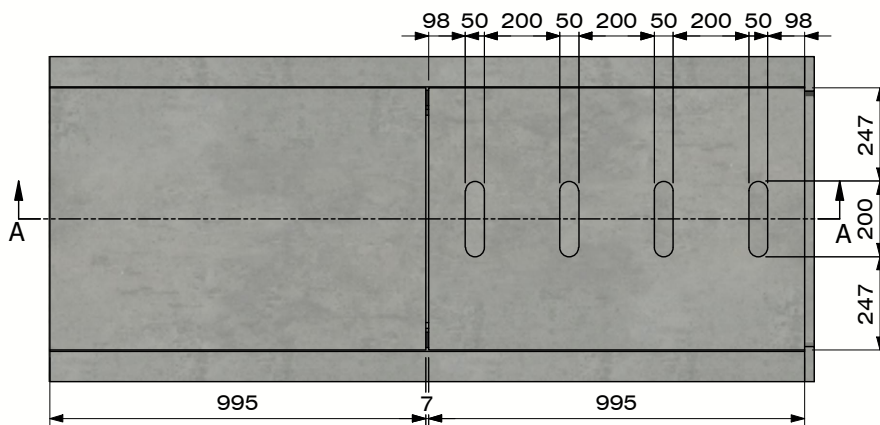
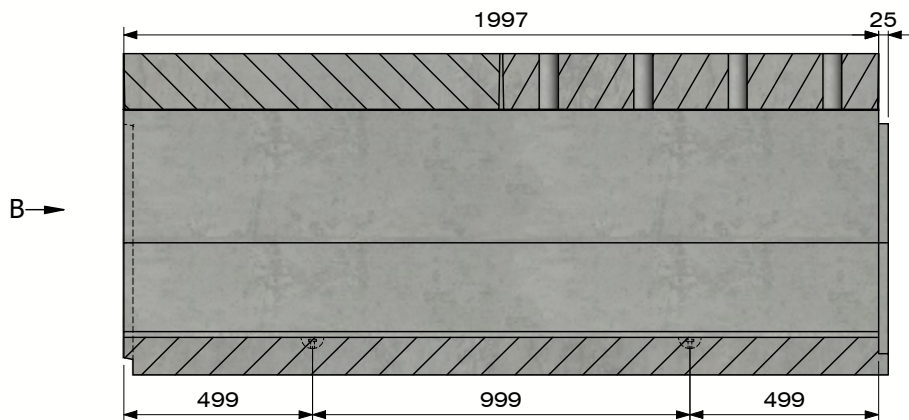

Couvercles avec ouvertures

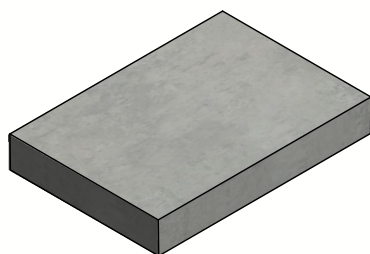

Couvercles sans ouvertures

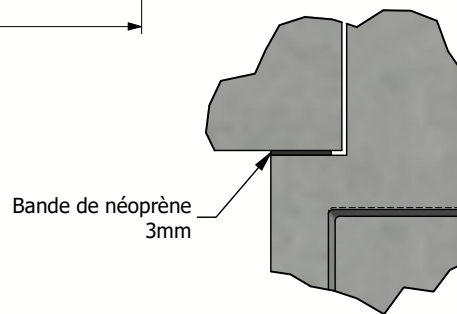

Detail D

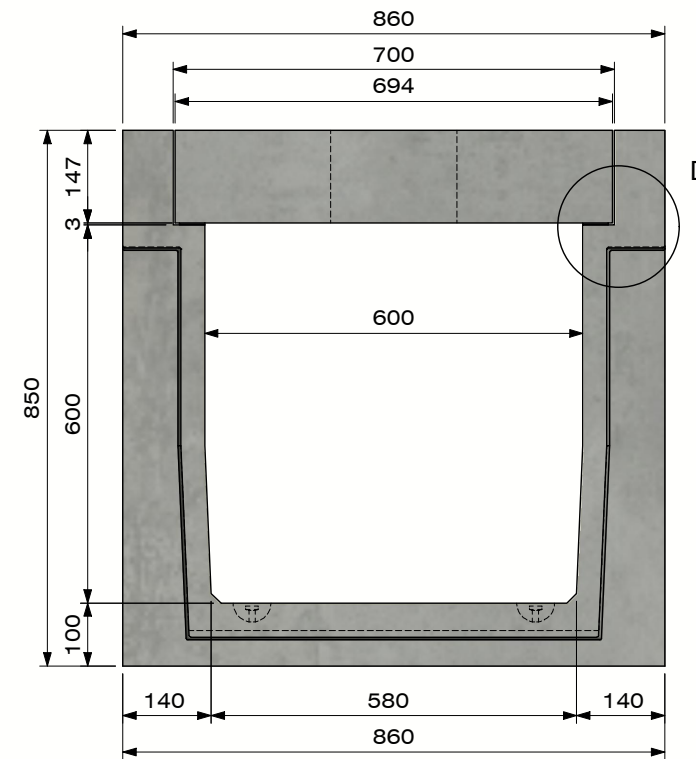

Vue B



B.P.M.N. SA
Chaussée de namur 2 , B-5150 Floriffoux

Projet : **Fiche technique**

N° art. : DELTA-U6006002000B150D

N° rev. : 0 Date rev. : 6/01/2021

