

DELTA-O slot channel DN400 - serie BB - Type I

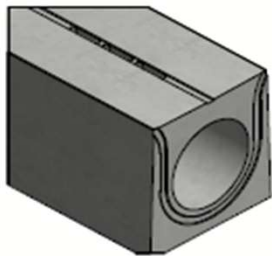

EPDM pressure joint

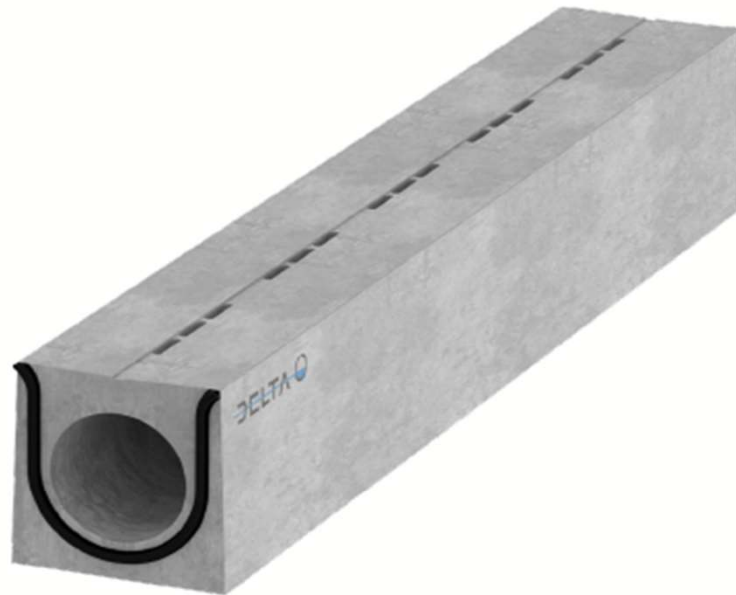
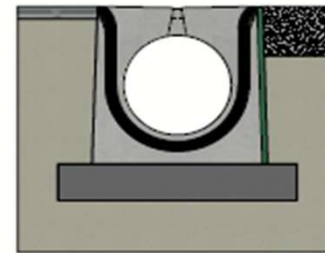
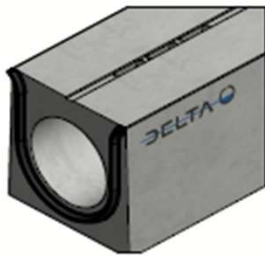

Installation guidelines Type I
(consult our detailed instructions)



Load class:	D400-E600-F900 cf EN1433
Absorption surface cm ² /m:	185
Slot type:	concrete
Edges:	concrete
Section cm ² :	1295
Concrete type:	C60/75
Environmental class:	XD3-XF4-XC4-XA3
Durability:	W+R
Length:	4000
Slope:	0
Gradient surface:	centric 1%
Connection type:	pressure joint
Lifting:	2 x lifting key
Installation guidelines:	specifications manufacturer
Standard:	in conformity with EN1446
Weight kg:	2604





Technical datasheet

Art. n°:	DELTA-O4004000BB		
Rev.n°:	0	REV.Date:	05/04/2023







DELTA-O slot channel DN400 - serie BB - Type I

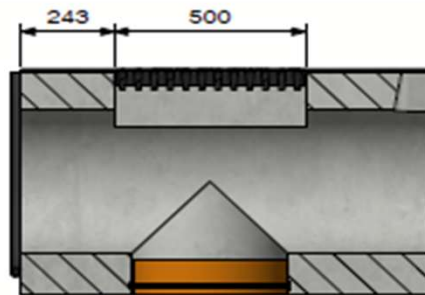
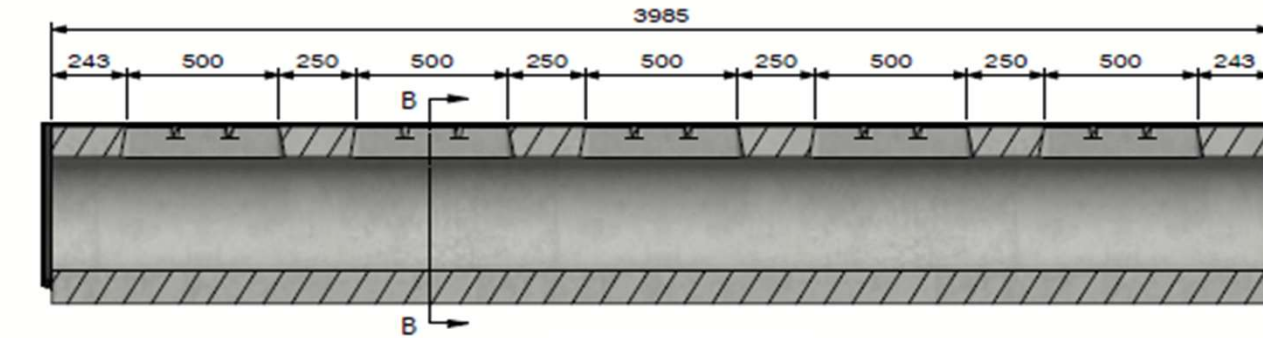

- GIR optional:

- Integrated inspection grating
- D400-E600
- Sealable
- Bottom drain optional

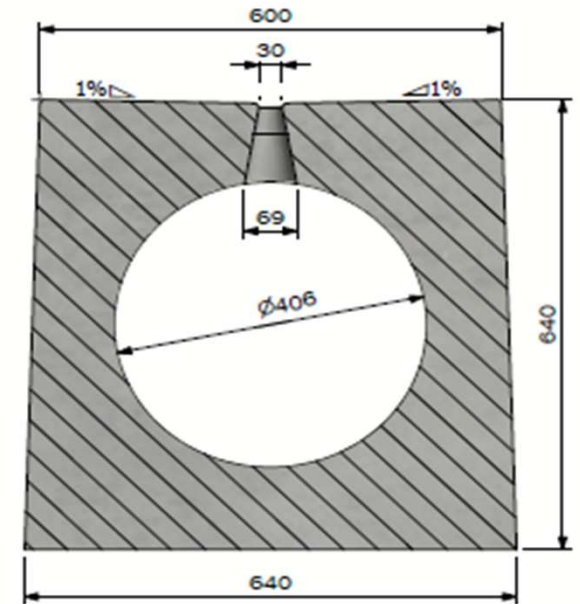

View B

DELTA O	
 PUSHING CONCRETE FURTHER	
Technical datasheet	
Art. n°:	DELTA-O4004000BB
Rev.n°:	0
REV.Date:	05/04/2023