

DELTA-O sand trap Ø400 2 connection PVCØ315

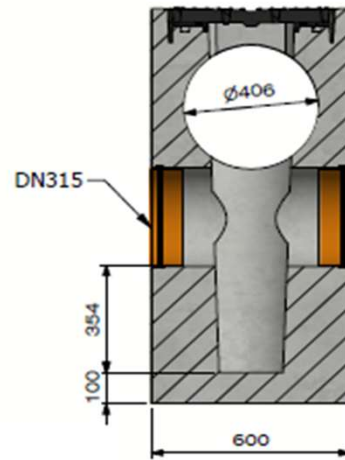

Load class:	N/A
Absorption surface cm ² /m:	0
Slot type:	N/A
Edges:	concrete
Section cm ² :	N/A
Concrete type:	C60/75
Environmental class:	XD3-XF4-XC4-XA3
Durability:	W+R
Length:	100
Slope:	N/A
Gradient surface:	N/A
Connection type:	pressure joint
Lifting:	4 x DH 1,3T
Installation guidelines:	specifications manufacturer
Standard:	N/A
Weight kg:	873

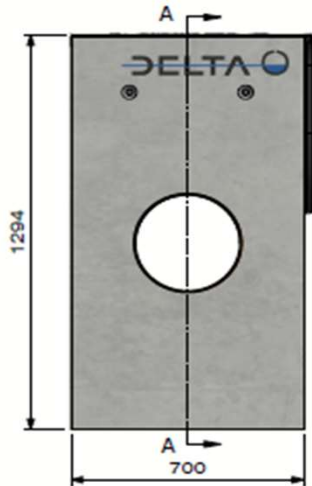



Technical datasheet

Art. n°:	DELTA-O400ZVE-2X315		
Rev.n°:	0	REV.Date:	05/04/2023





