

DELTA-O Ø500 end plate

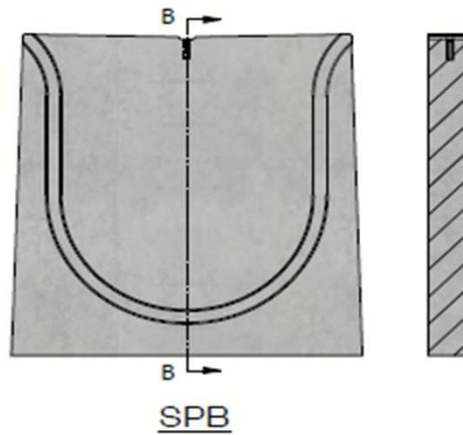

Load class:	N/A
Absorption surface cm ² /m:	0
Slot type:	N/A
Edges:	concrete
Section cm ² :	N/A
Concrete type:	C60/75
Environmental class:	XD3-XF4-XC4-XA3
Durability:	W+R
Length:	100
Slope:	N/A
Gradient surface:	N/A
Connection type:	pressure joint
Lifting:	1 x M12 lifting insert
Installation guidelines:	specifications manufacturer
Standard:	N/A
Weight kg:	99

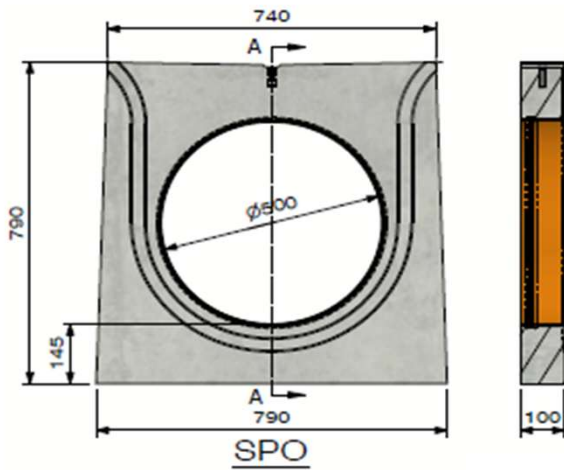



Technical datasheet

Art. n°:	DELTA-O500SP		
Rev.n°:	0	REV.Date:	05/04/2023





