

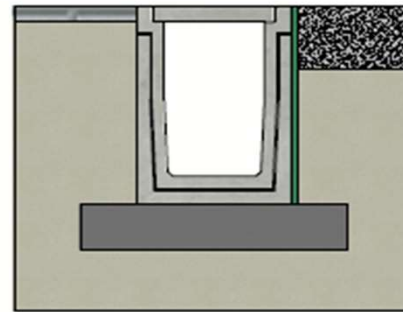

DELTA-U CHANNEL 300x500 SERIES B050 TYPE I

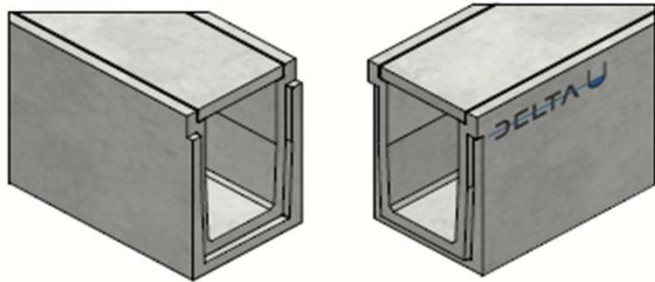

Installation guidelines Type I
(consult our detailed instructions)





Load class:	A15 of EN1433
Absorption surface cm ² /m:	N/A
Slot type:	N/A
Edges:	concrete
Section cm ² :	1500
Concrete type:	C60/75
Environmental class:	XD3-XF4-XC4-XA3
Durability:	W+R
Length:	3000
Slope:	0
Gradient surface:	N/A
Connection type:	Tongue and groove
Lifting:	4 x DH 1,3T
Installation guidelines:	specifications manufacturer
Standard:	in conformity with EN1433
Weight kg:	1095





Technical datasheet

Art. n°:	DELTA-U3005003000B050A	
Rev.n°:	0	REV.Date: 05/04/2023

DELTA-U CHANNEL 300x500 SERIES B050 TYPE I

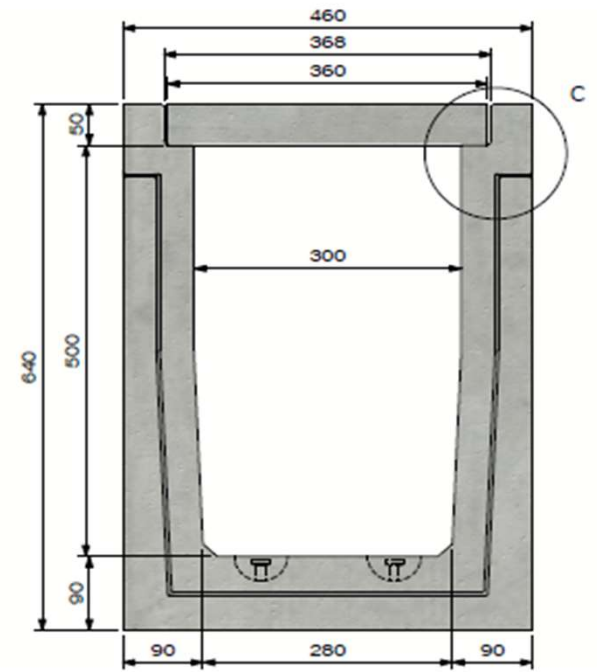
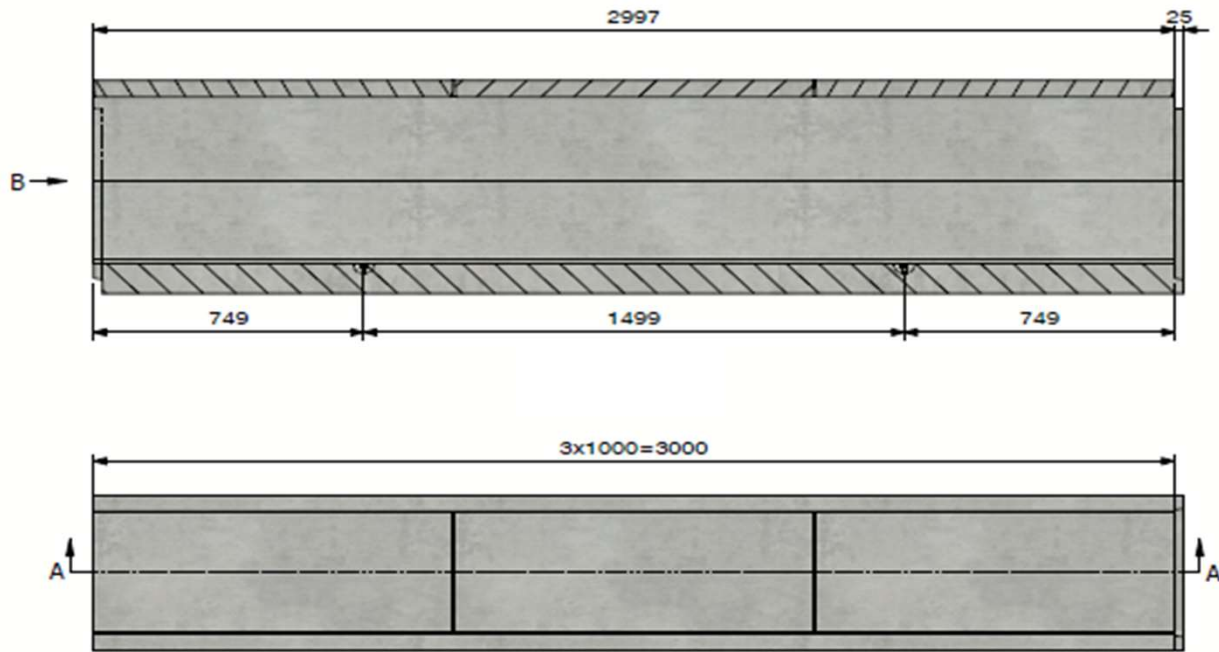

View B

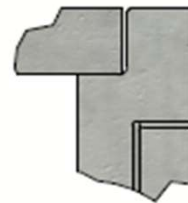
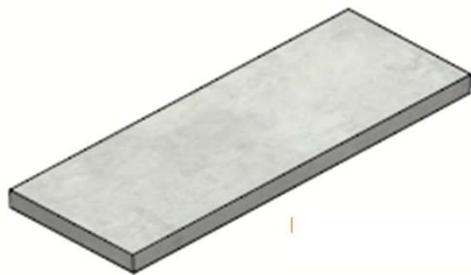

Detail C

DELTA U	
 DE BONTE GROUP <small>PUSHING CONCRETE FURTHER</small>	
Technical datasheet	
Art. n°:	DELTA-U3005003000B050A
Rev.n°:	0
REV.Date:	05/04/2023
