

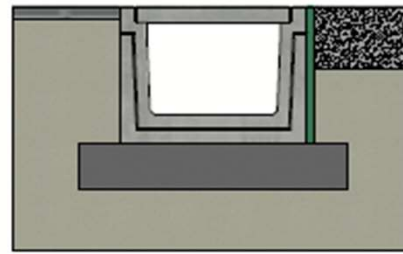

# DELTA-U CHANNEL 400x300 SERIES B050 TYPE I

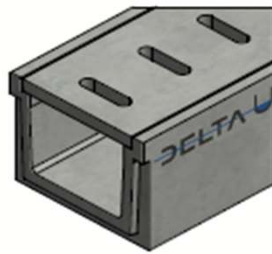

Installation guidelines Type I  
(consult our detailed instructions)

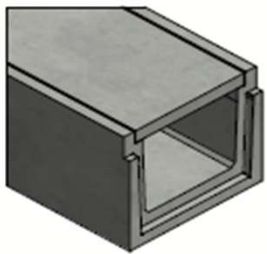
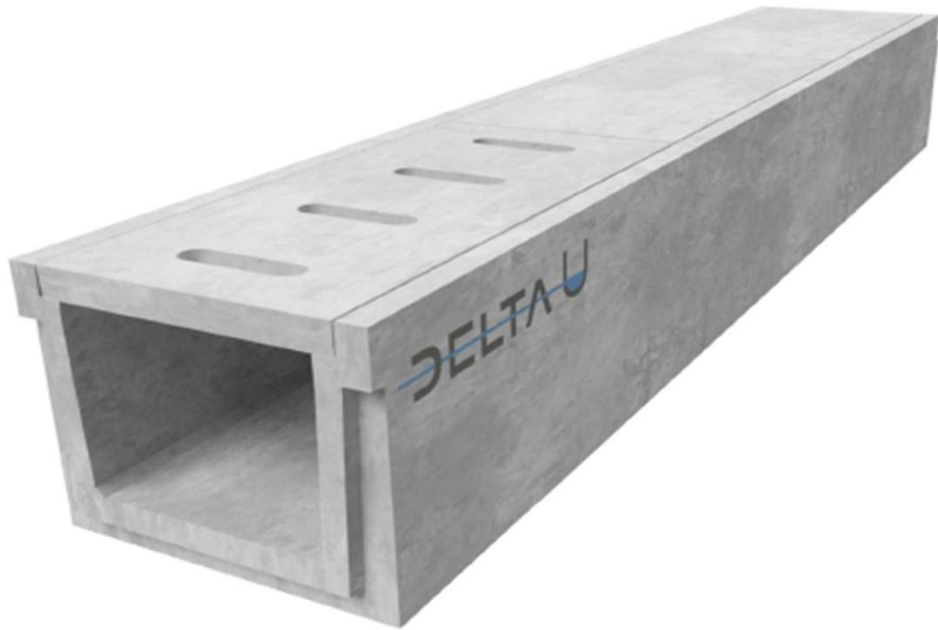



Load class:	A15 of EN1433
Absorption surface cm <sup>2</sup> /m:	N/A
Slot type:	N/A
Edges:	concrete
Section cm <sup>2</sup> :	1200
Concrete type:	C60/75
Environmental class:	XD3-XF4-XC4-XA3
Durability:	W+R
Length:	3000
Slope:	0
Gradient surface:	N/A
Connection type:	Tongue and groove
Lifting:	4 x DH 1,3T
Installation guidelines:	specifications manufacturer
Standard:	in conformity with EN1433
Weight kg:	943





**Technical datasheet**

Art. n°:	DELTA-U4003003000B050A	
Rev.n°:	0	REV.Date: 05/04/2023

# DELTA-U CHANNEL 400x300 SERIES B050 TYPE I

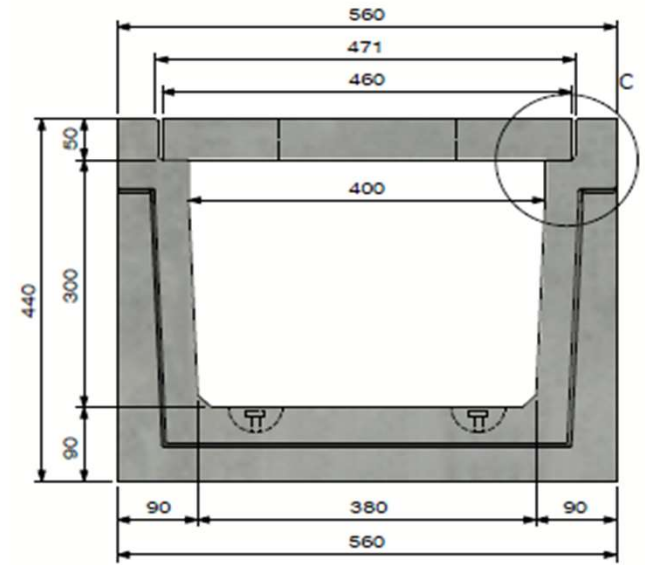
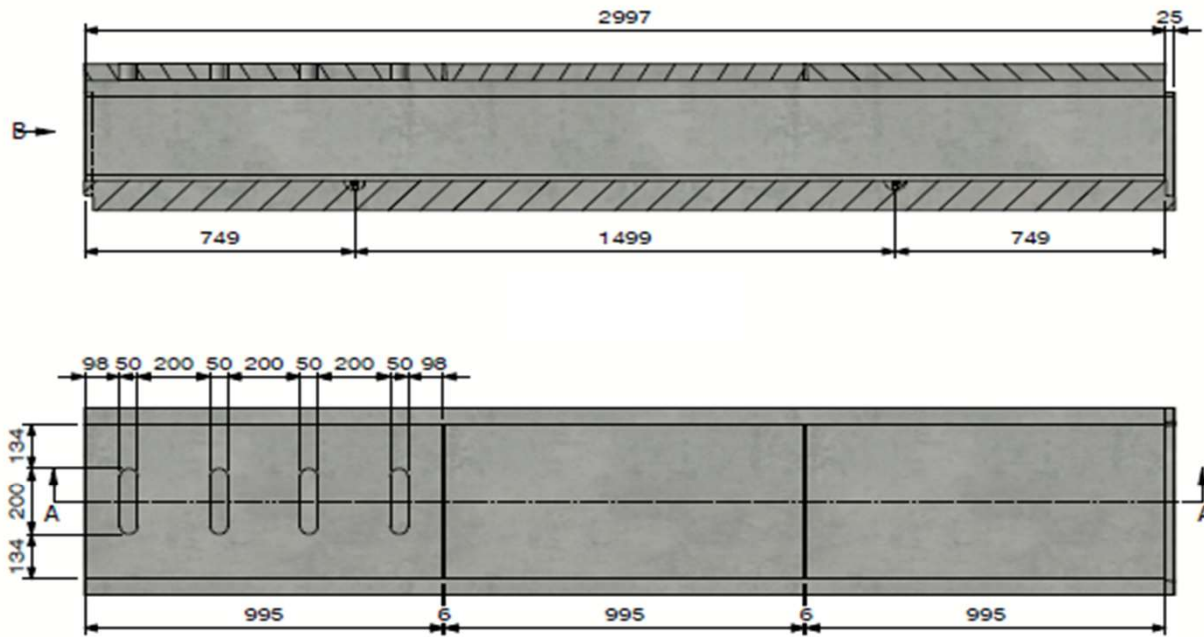

View B

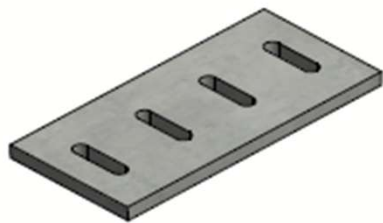

Detail C



---



PUSHING CONCRETE FURTHER

---

**Technical datasheet**

Art. n°:	DELTA-U4003003000B050A		
Rev.n°:	0	REV.Date:	05/04/2023

---



