

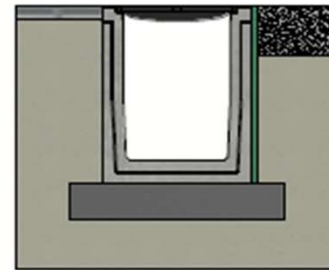

DELTA-U CHANNEL with CAST IRON GRATING 400x600 SERIES G025 TYPE I

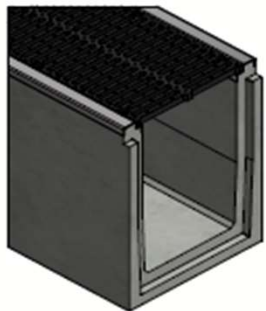

Installation guidelines Type I
(consult our detailed instructions)





Load class:	D400-F900 cf EN1433
Absorption surface cm ² /m:	N/A
Slot type:	N/A
Edges:	galvanised steel
Section cm ² :	2400
Concrete type:	C60/75
Environmental class:	XD3-XF4-XC4-XA3
Durability:	W+R
Length:	3000
Slope:	0
Gradient surface:	N/A
Connection type:	Tongue and groove
Lifting:	4 x DH 1,3T
Installation guidelines:	specifications manufacturer
Standard:	in conformity with EN1433
Weight kg:	1364





Technical datasheet

Art. n°:	DELTA-U4006003000G025	
Rev.n°:	0	REV.Date: 05/04/2023

DELTA-U CHANNEL with CAST IRON GRATING 400x600 SERIES G025 TYPE I

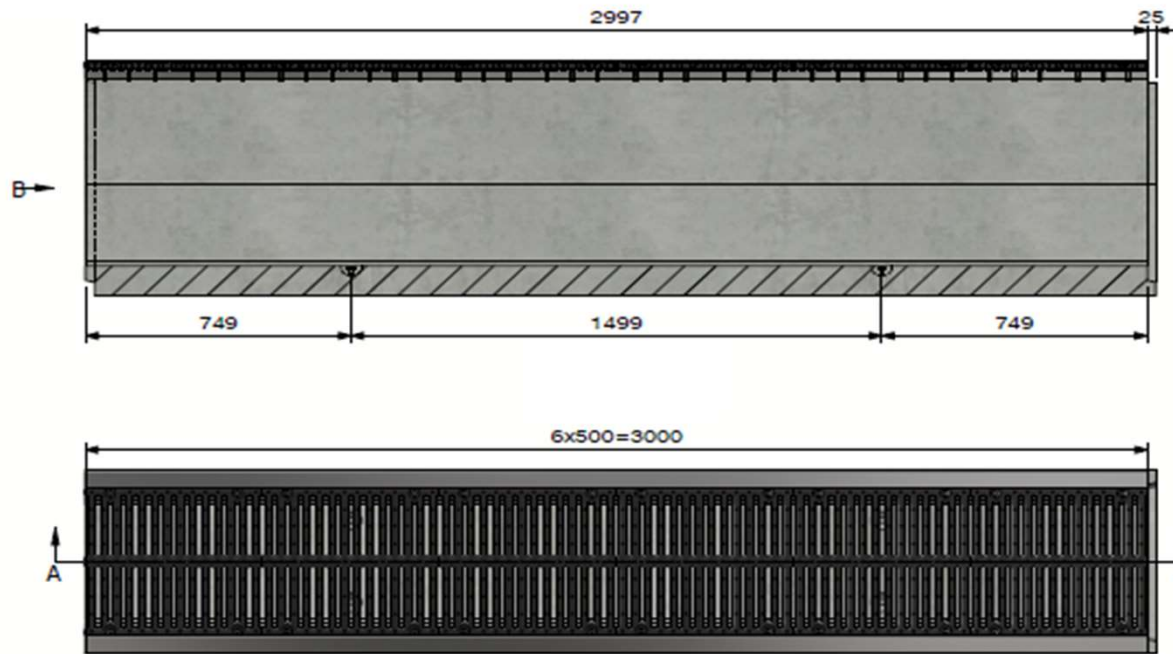

D400 : DELTA-U400D500IS025D-DR
F900 : DELTA-U400D500IS025F-DR



Detail C

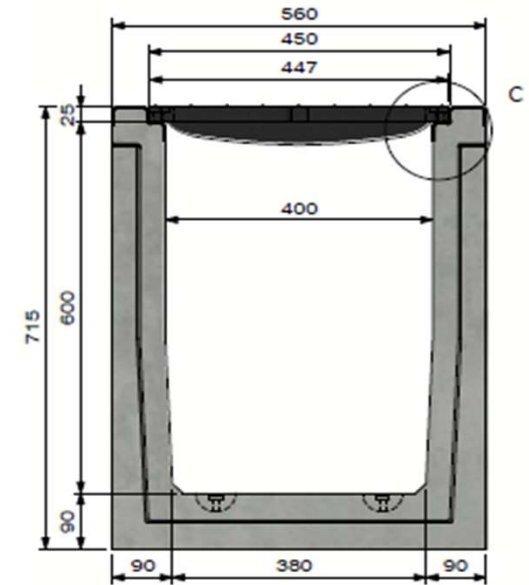

View B

PUSHING CONCRETE FURTHER	
Technical datasheet	
Art. n°:	DELTA-U4006003000G025
Rev.n°:	0
REV.Date:	05/04/2023



www.delta-drainworld.com