

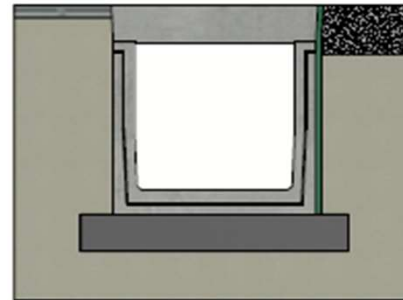

# DELTA-U CHANNEL 600x600 SERIES B000 TYPE I

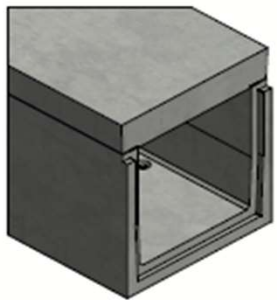

Installation guidelines Type I  
(consult our detailed instructions)





Load class:	D400 of EN1433
Absorption surface cm <sup>2</sup> /m:	N/A
Slot type:	N/A
Edges:	concrete
Section cm <sup>2</sup> :	3600
Concrete type:	C60/75
Environmental class:	XD3-XF4-XC4-XA3
Durability:	W+R
Length:	2000
Slope:	0
Gradient surface:	N/A
Connection type:	Tongue and groove
Lifting:	4 x DH 1,3T
Installation guidelines:	specifications manufacturer
Standard:	tested according EN1433
Weight kg:	1473





**Technical datasheet**

Art. n°:	DELTA-U6006002000B000D		
Rev.n°:	0	REV.Date:	05/04/2023

# DELTA-U CHANNEL 600x600 SERIES B000 TYPE I

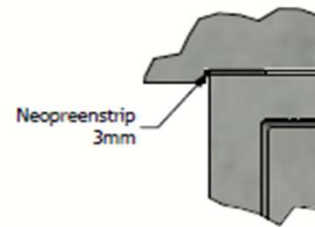
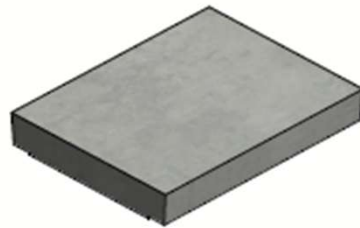
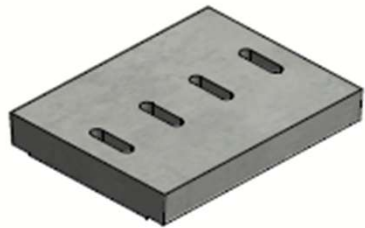
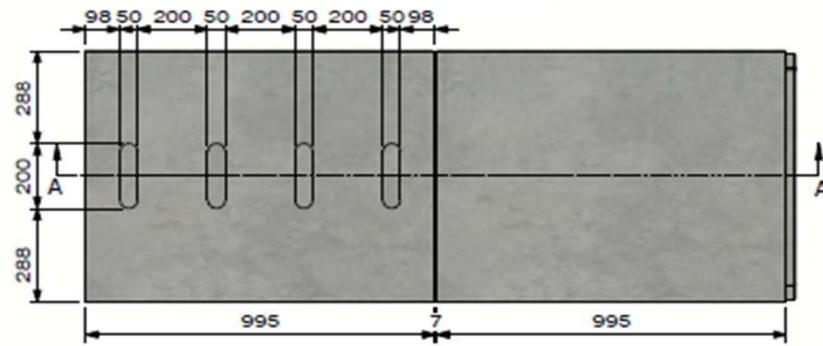
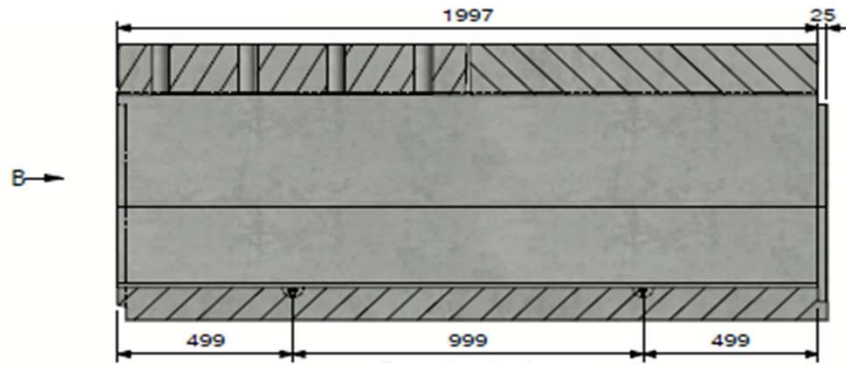

Detail D

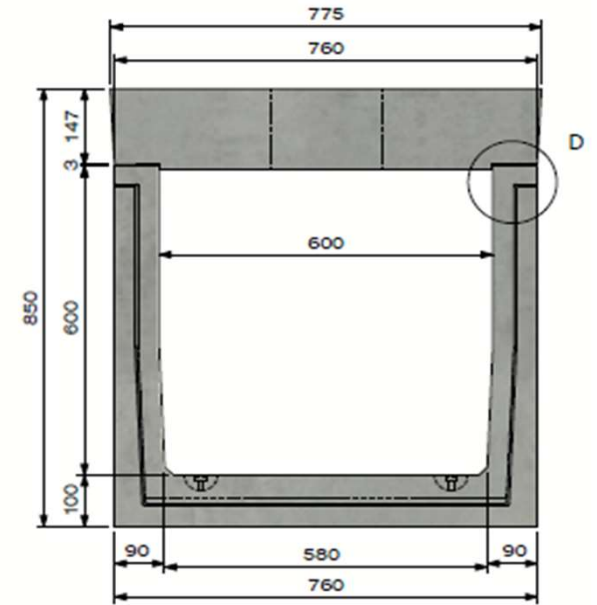

View B

PUSHING CONCRETE FURTHER	
<b>Technical datasheet</b>	
Art. n°:	DELTA-U6006002000B000D
Rev.n°:	0
REV.Date:	05/04/2023