

DELTA-U CHANNEL 600x600 SERIES B150 TYPE I

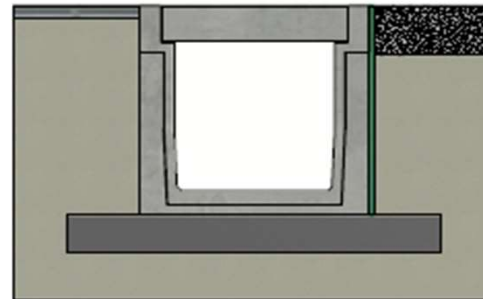

Installation guidelines Type I
(consult our detailed instructions)

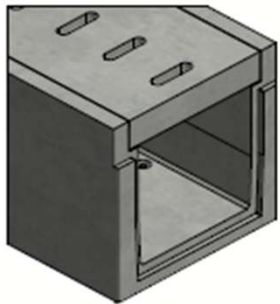

Load class:	D400 of EN1433
Absorption surface cm ² /m:	N/A
Slot type:	N/A
Edges:	concrete
Section cm ² :	3600
Concrete type:	C60/75
Environmental class:	XD3-XF4-XC4-XA3
Durability:	W+R
Length:	2000
Slope:	0
Gradient surface:	N/A
Connection type:	Tongue and groove
Lifting:	4 x DH 1,3T
Installation guidelines:	specifications manufacturer
Standard:	tested according EN1433
Weight kg:	1863





Technical datasheet

Art. n°:	DELTA-U6006002000B150D		
Rev.n°:	0	REV.Date:	05/04/2023



DELTA-U CHANNEL 600x600 SERIES B150 TYPE I

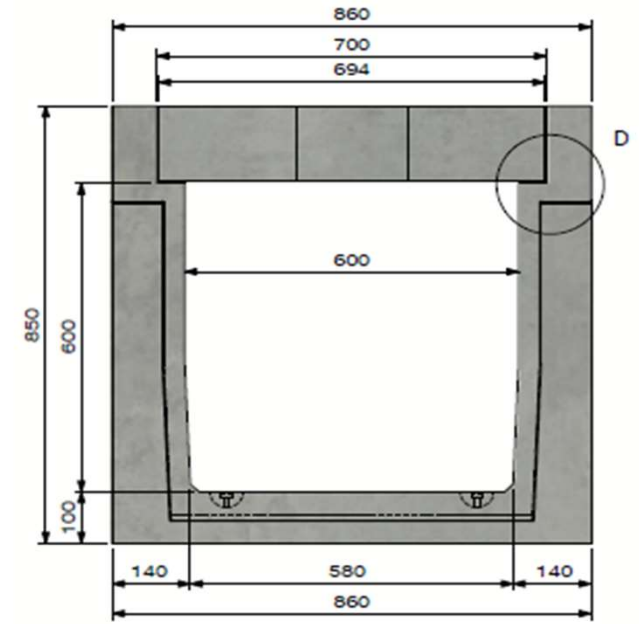
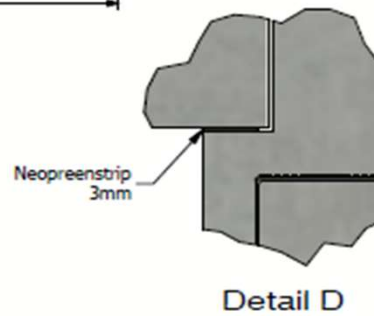
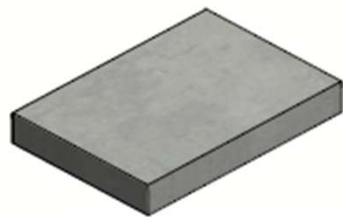
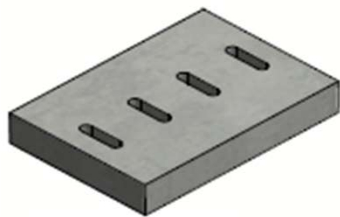
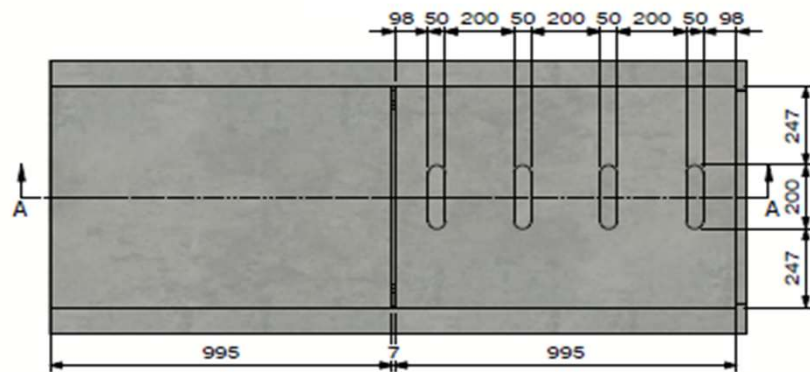
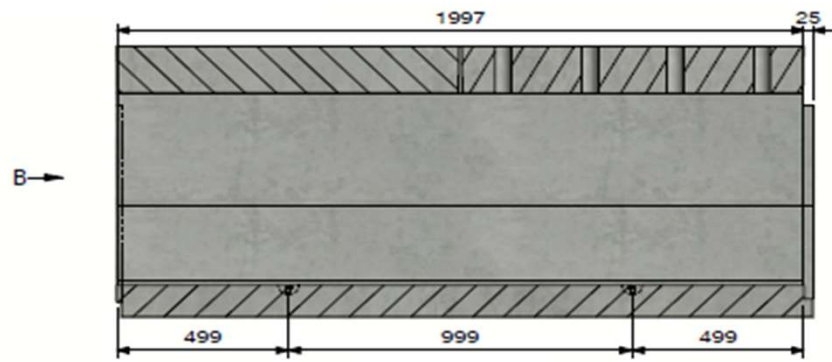

View B





PUSHING CONCRETE FURTHER

Technical datasheet

Art. n°:	DELTA-U6006002000B150D		
Rev.n°:	0	REV.Date:	05/04/2023