

DELTA-O verholen goot DN500 - serie SB - Type I

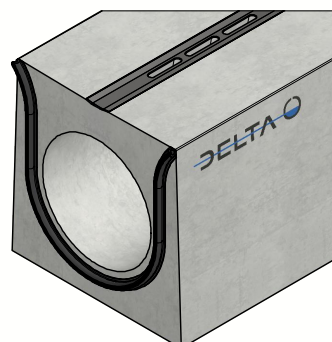

Drukverbinding met EPDM
rubberdichting

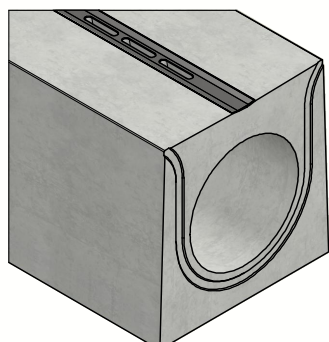
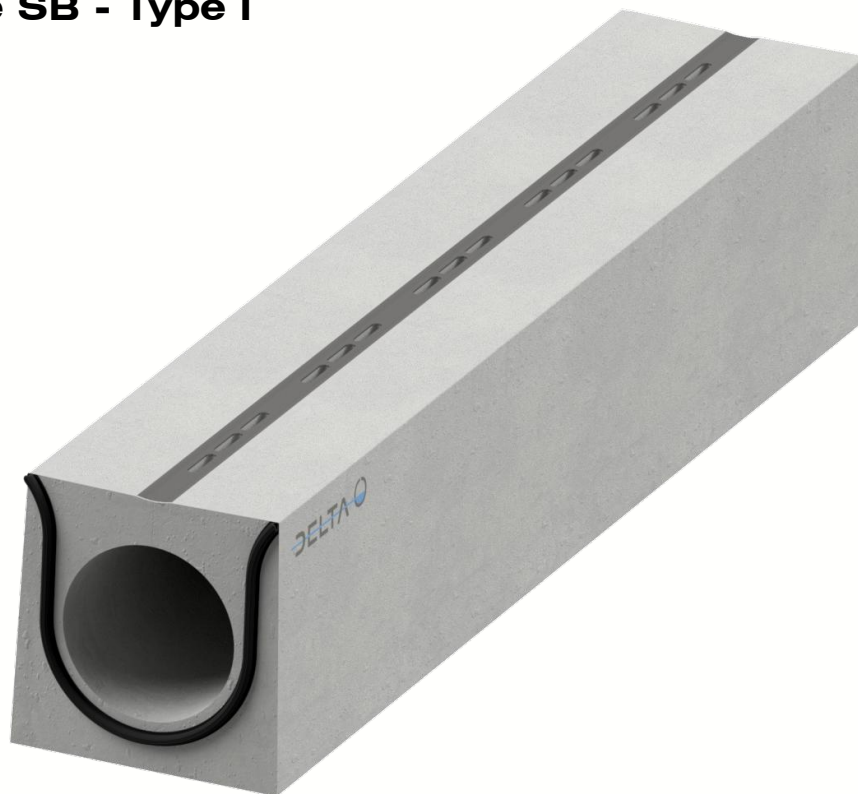
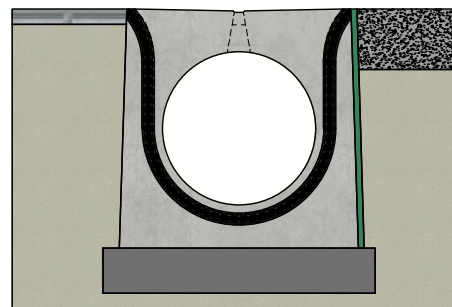

Principe type I
(Raadpleeg de plaatsingsvoorschriften)



| | |
|---|---------------------------------------|
| Belastingsklasse: | D4+M66+M67:AC69+M66+M67:AC69+M67:AE68 |
| Instroomoppervlak cm ² / lm: | 286 |
| Sleufprofieltype: | staal |
| Randen: | beton |
| Sectie stroomprofiel cm ² : | 1962 |
| Betonsterkteklasse: | C60/75 |
| Omgevingsklassen: | XD3-XF4-XC4-XA3 |
| Duurzaamheid: | W+R |
| Werkende lengte: | 4000 |
| Helling stroomprofiel: | 0 |
| Helling bovenvlak: | centrisch 1% |
| Verbinding: | drukverbinding |
| Hijsvoorziening: | 2 x hijssleutel |
| Plaatsingsvoorschrift: | volgens opgave producent |
| Normering: | conform EN1433 |
| Gewicht: | 3948 Kg |

| | |
|--------------|-------------------------|
| | |
| | |
| Project : | Technische fiche |
| Art. nr. : | DELTA-O5004000SB |
| REV. nr. : | 0 |
| REV. Datum : | 27/01/2023 |
| | |

DELTA-O verholen goot DN500 - serie SB - Type I

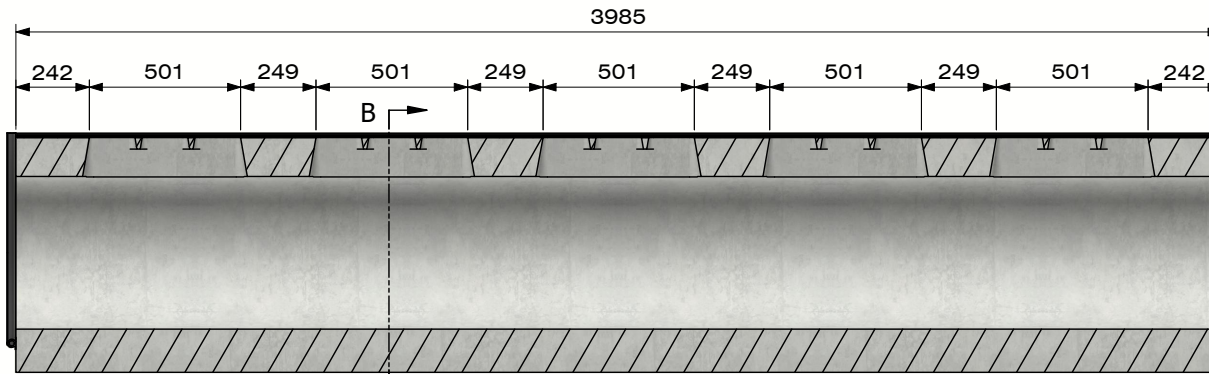

Sectie A-A
(Schaal 1 : 25)

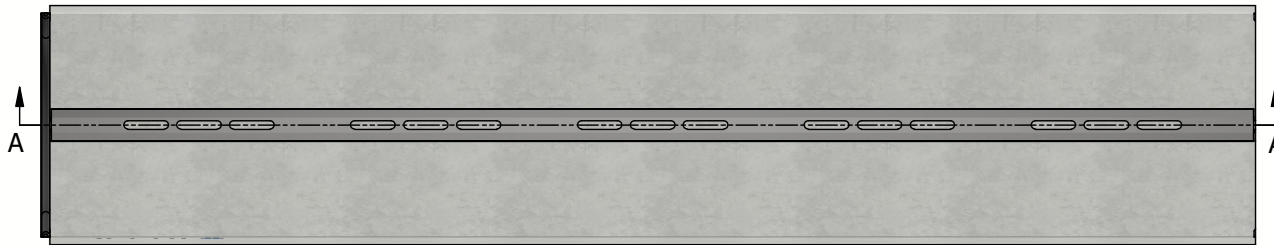

Sectie B-B
(Schaal 1 : 10)

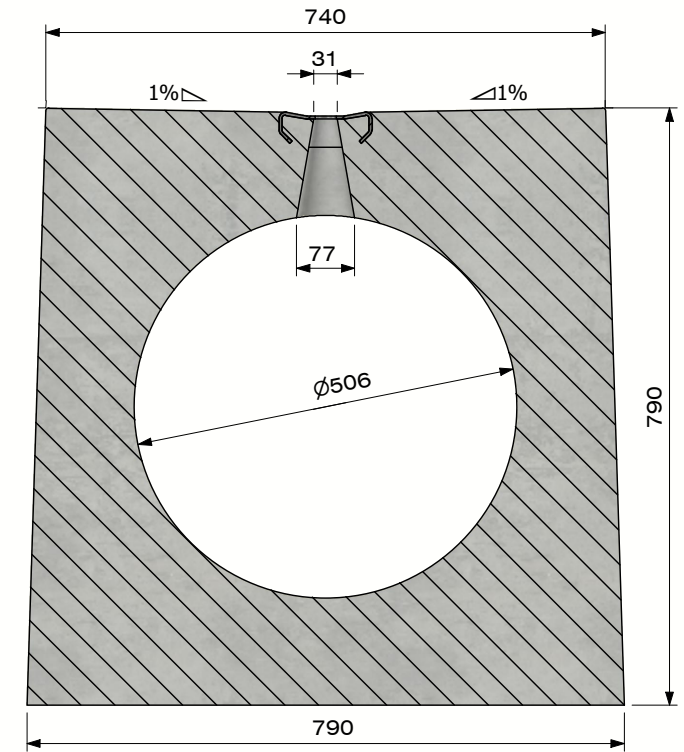

- Optie GIR :

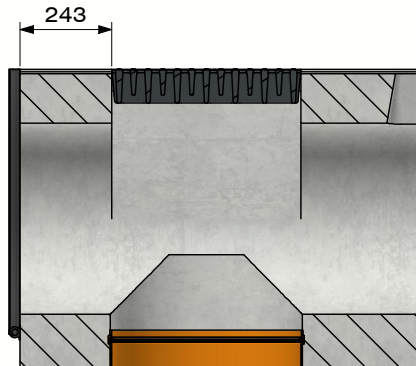

- Geïntegreerd inspectierooster
- D400-E600-F900
- Vergrendelbaar
- Optioneel bodemaafloop





DE BONTE GROUP
PUSHING CONCRETE FURTHER

| | | |
|------------|-------------------------|-------------------------|
| Project : | Technische fiche | |
| Art. nr. : | DELTA-O5004000SB | |
| REV. nr. : | 0 | REV. Datum : 27/01/2023 |



BSB
Bouwstoffenbestel