

DELTA-O verholen goot DN600 - serie BB - Type I

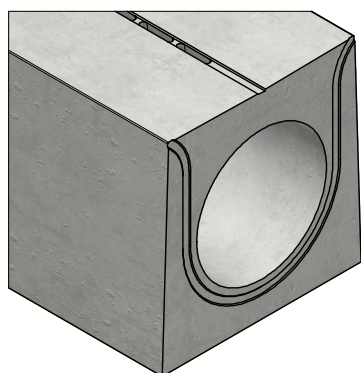

Drukverbinding met EPDM
rubberdichting

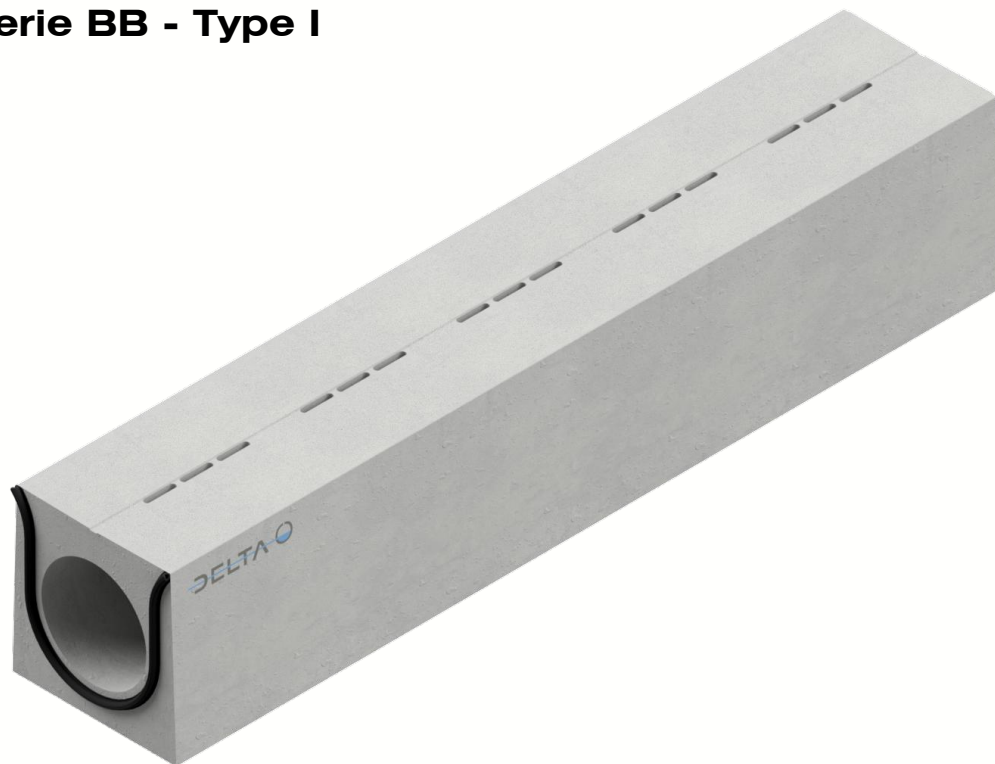
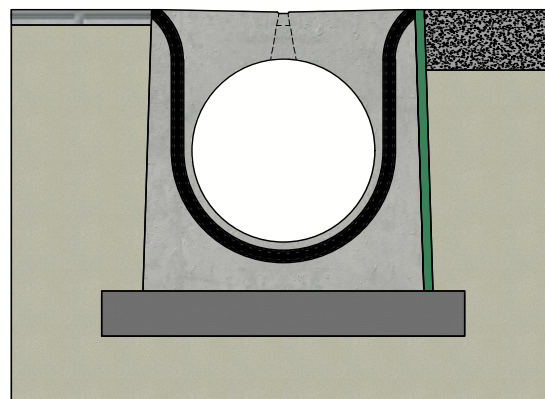

Principe type I
(Raadpleeg de plaatsingsvoorschriften)



Belastingsklasse:	D400-E600-F900 cf EN1433
Instroomoppervlak cm ² / lm:	286
Sleufprofieltype:	beton, fietsveilig
Randen:	beton
Sectie stroomprofiel cm ² :	2826
Betonsterkteklasse:	C60/75
Omgevingsklassen:	XD3-XF4-XC4-XA3
Duurzaamheid:	W+R
Werkende lengte:	4000
Helling stroomprofiel:	0
Helling bovenvlak:	centrisch 1%
Verbinding:	drukverbinding
Hijsvoorziening:	2 x hijssleutel
Plaatsingsvoorschrift:	volgens opgave producent
Normering:	conform EN1433
Gewicht:	5362 Kg





Project :	Technische fiche	
Art. nr. :	DELTA-O6004000BB	
REV. nr. :	0	REV. Datum : 10/02/2023



DELTA-O verholen goot DN600 - serie BB - Type I

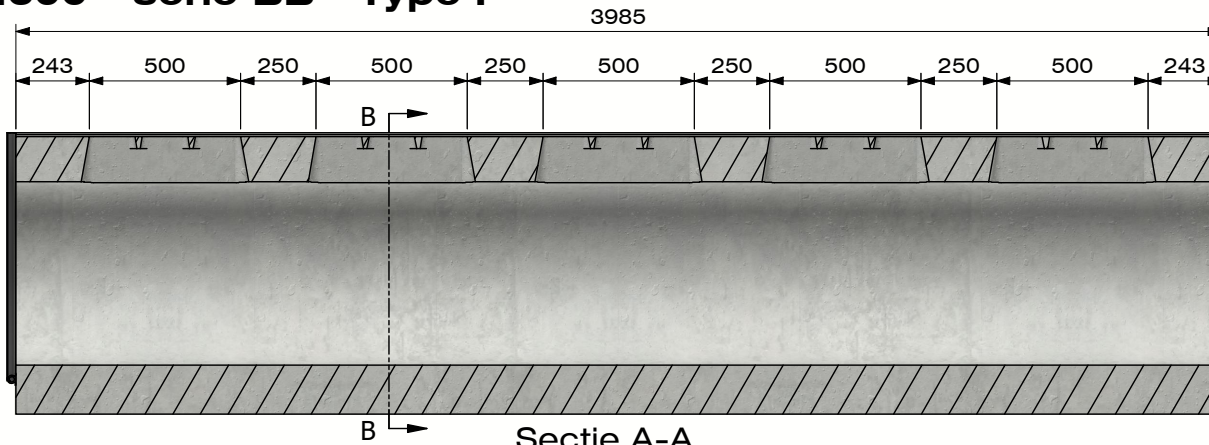

Sectie A-A
(Schaal 1 : 25)

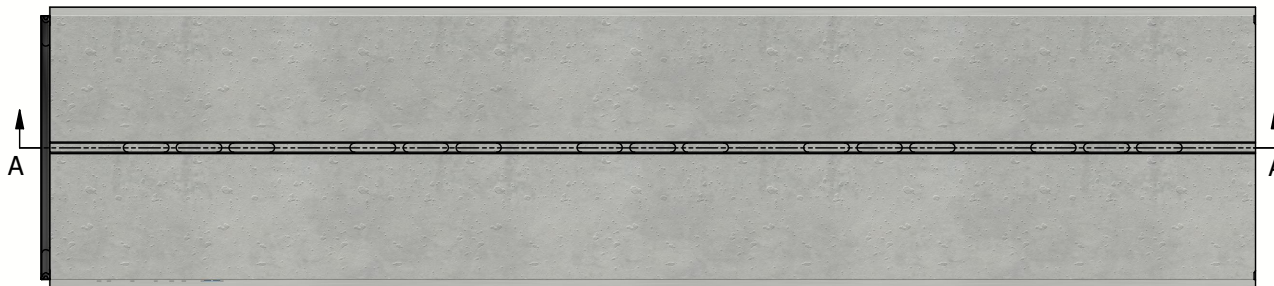

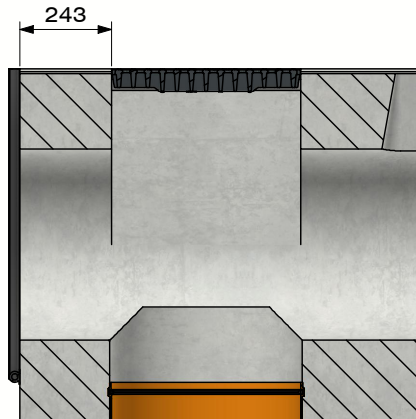

Sectie B-B
(Schaal 1 : 15)

- Optie GIR :



Geïntegreerd inspectierooster
- D400-E600-F900
- Vergrendelbaar
Optioneel bodemaafloop





DE BONTE GROUP
PUSHING CONCRETE FURTHER

Project :	Technische fiche	
Art. nr. :	DELTA-O6004000BB	
REV. nr. :	0	REV. Datum : 10/02/2023



BSB
bouwstoffenbestel