

# DELTA-O verholen goot DN600 - serie SB - Type I

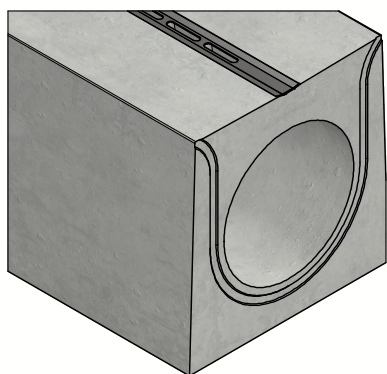

Drukverbinding met EPDM  
rubberdichting

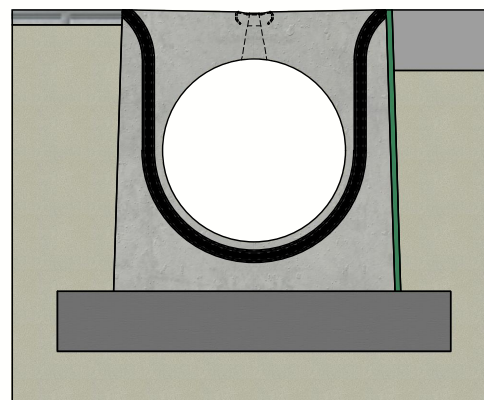
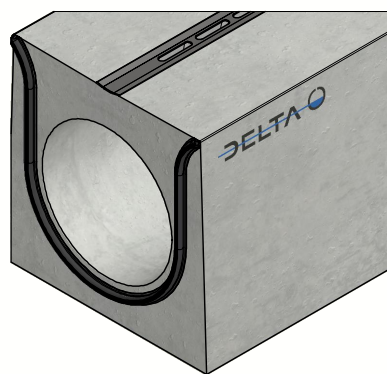

Principe type I  
(Raadpleeg de plaatsingsvoorschriften)



Belastingsklasse:	D400-E600-F900 cf EN1433
Instroomoppervlak cm <sup>2</sup> / lm:	286
Sleufprofieltype:	staal
Randen:	beton
Sectie stroomprofiel cm <sup>2</sup> :	2826
Betonsterkteklasse:	C60/75
Omgevingsklassen:	XD3-XF4-XC4-XA3
Duurzaamheid:	W+R
Werkende lengte:	4000
Helling stroomprofiel:	0
Helling bovenvlak:	centrisch 1%
Verbinding:	drukverbinding
Hijsvoorziening:	2 x hijsleutel
Plaatsingsvoorschrift:	volgens opgave producent
Normering:	conform EN1433
Gewicht:	5377 Kg





Project :	<b>Technische fiche</b>		
Art. nr. :	DELTA-O6004000SB		
REV. nr. :	0	REV. Datum :	10/02/2023



# DELTA-O verholen goot DN600 - serie SB - Type I

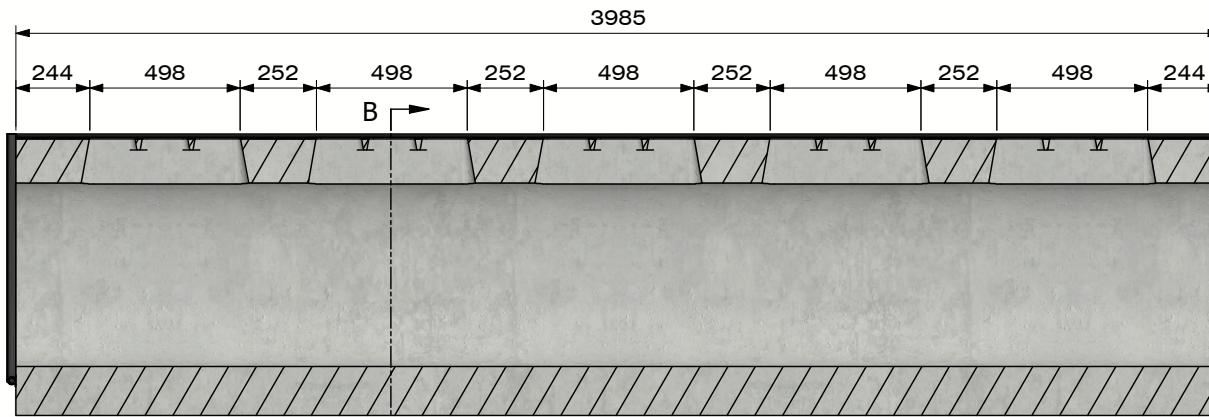

Sectie A-A  
(Schaal 1 : 25)

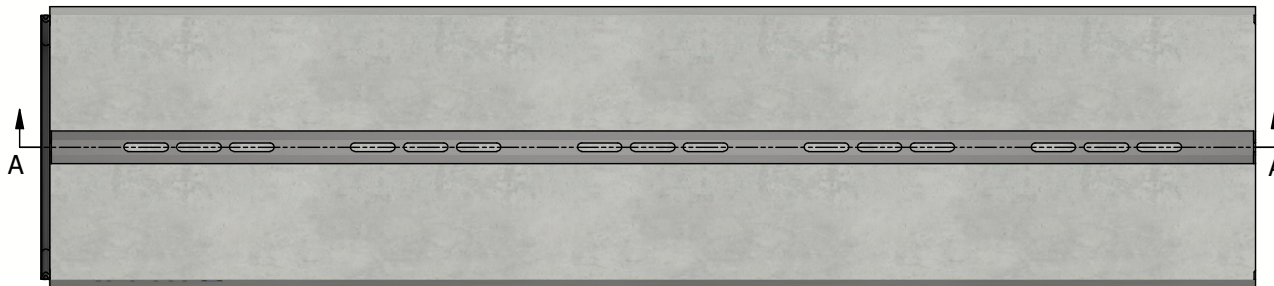

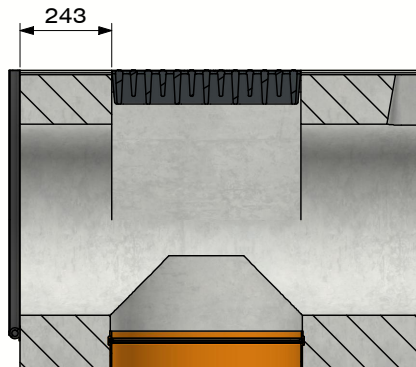

Sectie B-B  
(Schaal 1 : 15)

- Optie GIR :



Geïntegreerd inspectierooster  
- D400-E600-F900  
- Vergrendelbaar  
Optioneel bodemaafloop





DE BONTE GROUP  
PUSHING CONCRETE FURTHER

Project :	<b>Technische fiche</b>	
Art. nr. :	DELTA-O6004000SB	
REV. nr. :	0	REV. Datum : 10/02/2023



BSB  
Bouwstoffenbesluit