

# DELTA-O caniveau à fente DN600 - serie SS - Type I

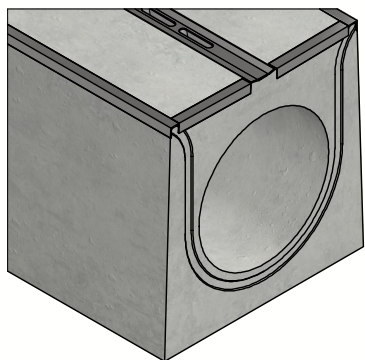

Liaison pression par joint  
EPDM

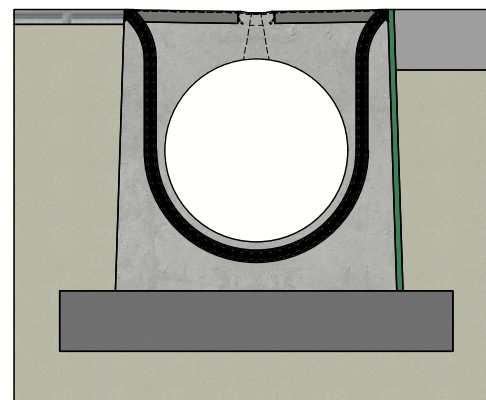

Principe type I  
(Consulter les prescriptions de pose)



Classe de charge:	D400-E600-F900 cf EN1433
Surface d'absorption cm <sup>2</sup> / m:	286
Fente type:	Acier
Bords:	Acier
Section d'écoulement cm <sup>2</sup> :	2628
Classe de résistance du béton:	C60/76
Classe d'exposition:	XD3-XF4-XC4-XA4
Durabilité:	W+R
Longueur de travail:	4000
Pente d'écoulement:	0
Pente surface supérieure:	0,01
Emboîtement:	par pression
Manutention:	2x clés de levage
Prescriptions de pose:	selon prescription fabricant
Norme:	conforme EN1434
Poids:	5392 Kg





Projet :	<b>Fiche technique</b>	
N° art. :	DELTA-O6004000SS	
N° rev. :	0	Date rev. : 14/02/2023



**DELTA-O caniveau à fente**  
**DN600 - serie SS - Type I**

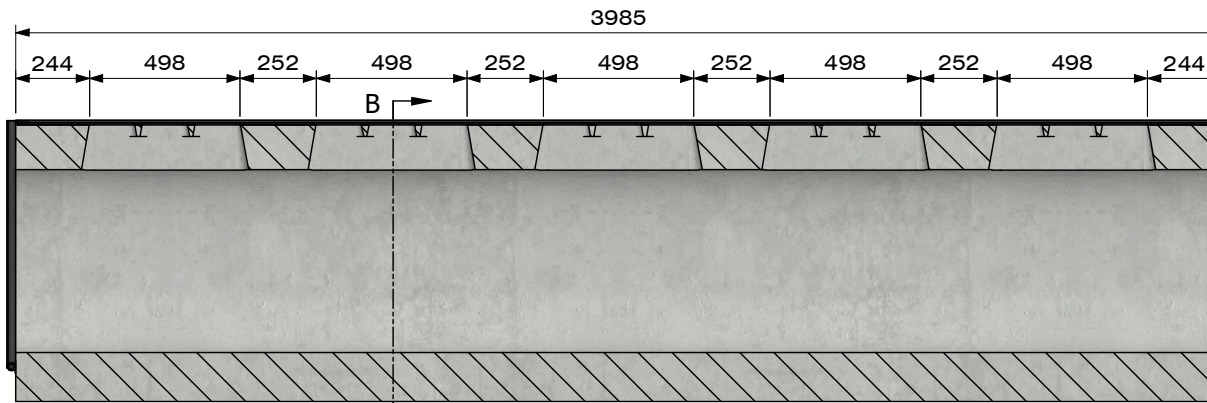

**Section A-A**  
 (Echelle 1 : 25)

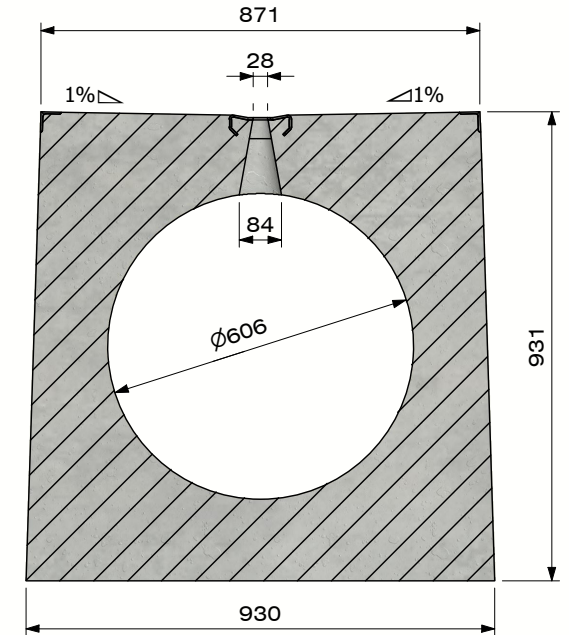
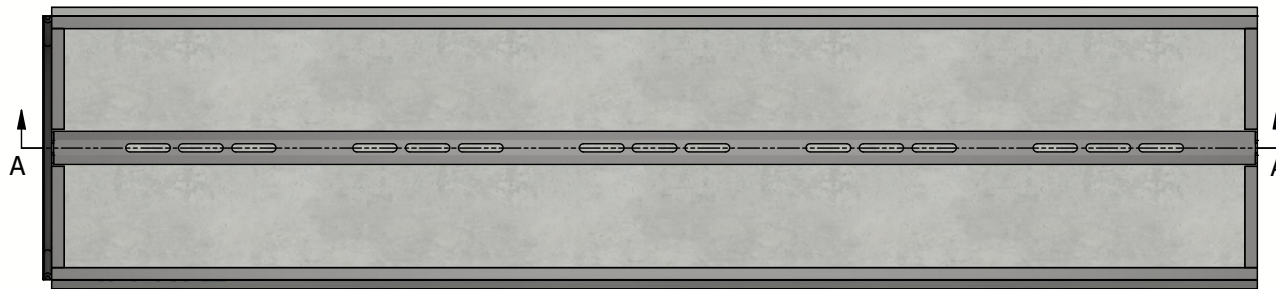

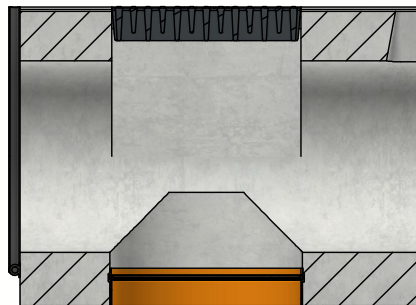

**Section B-B**  
 (Echelle 1 : 15)

- Option GIR :



Grille d'inspection intégrée  
 - D400-E600-F900  
 - Verrouillable  
 Option sortie verticale





DE BONTE GROUP  
PUSHING CONCRETE FURTHER

Projet :	<b>Fiche technique</b>	
N° art. :	DELTA-O6004000SS	
N° rev. :	0	Date rev. : 14/02/2023



BSB  
Bauwerkstoffbest