

DELTA-T GOOT 600x300 SERIE G060 TYPE I

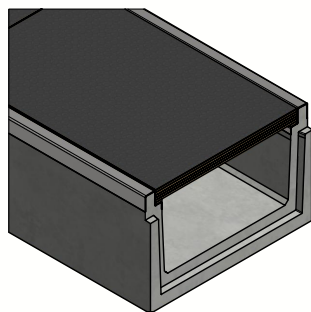

B125: Multiplex

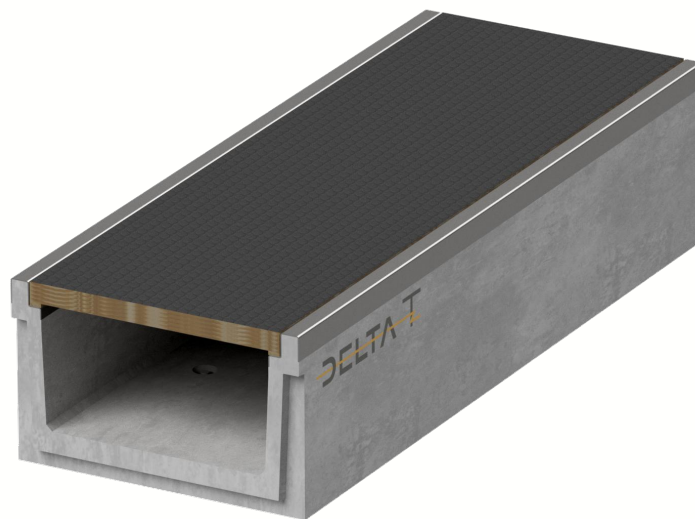
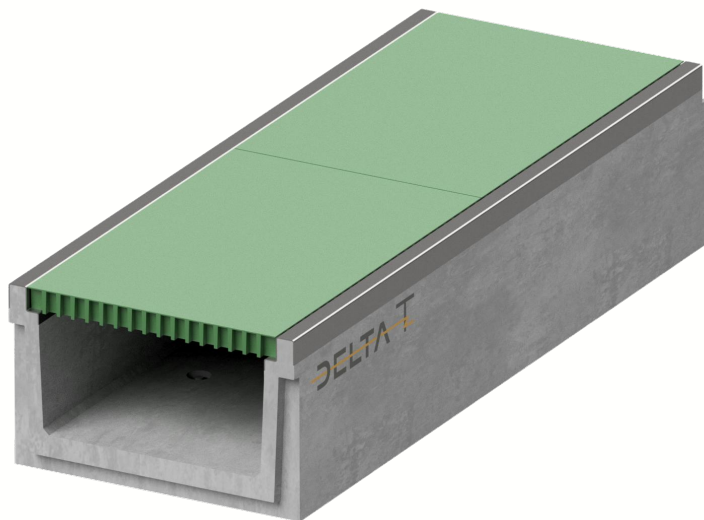
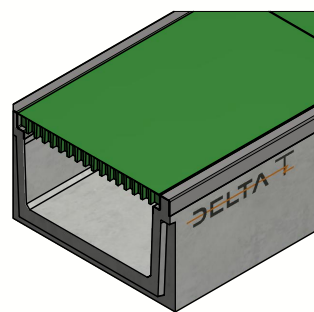

C250: Kunststof

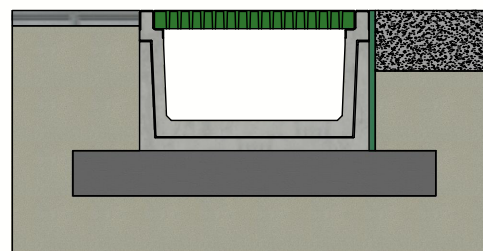

Principe type I
(Raadpleeg de plaatsingsvoorschriften)



Belastingsklasse:	B125-C250 of EN1433
Instroomoppervlak cm ² / lm:	N/A
Sleufprofieltype:	N/A
Randen:	staal, galva
Sectie stroomprofiel cm ² :	1800
Betonsterkteklasse:	C60/75
Omgevingsklassen:	XD3-XF4-XC4-XA3
Duurzaamheid:	W+R
Werkende lengte:	2000
Helling stroomprofiel:	0
Helling bovenvlak:	N/A
Verbinding:	T/G tand/groef
Hijsvoorziening:	4 x DH 1,3T
Plaatsingsvoorschrift:	volgens opgave producent
Normering:	conform EN1433
Gewicht:	694 Kg

DELTA T

B.P.M.N. SA
Chaussée de namur , B-5150 Floriffoux

Project :	Technische fiche	
Art. nr. :	DELTA-T6003002000G060	
REV. nr. :	0	REV. Datum : 8/03/2021



DELTA-T GOOT 600x300
SERIE G060 TYPE I

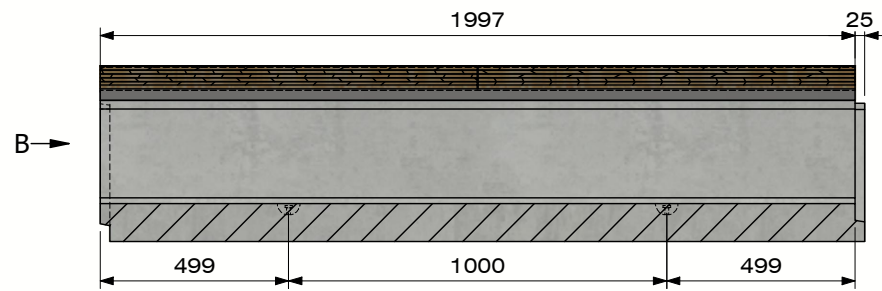

Sectie A-A
 (Schaal 1 : 20)

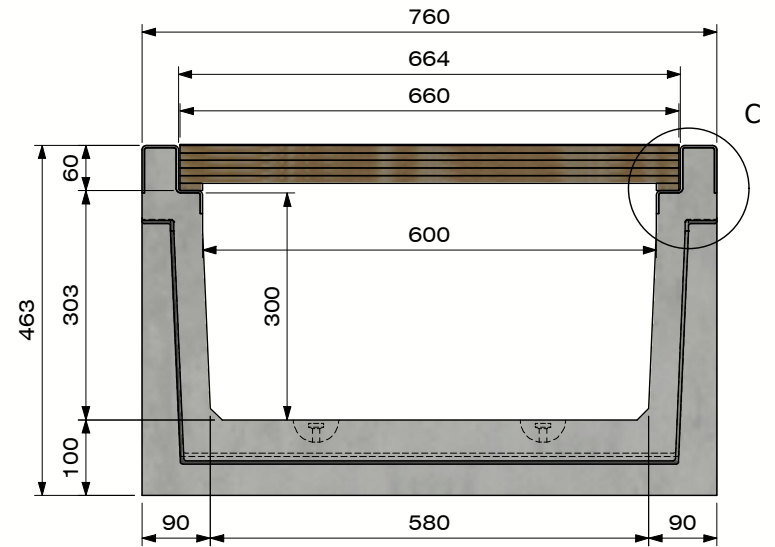
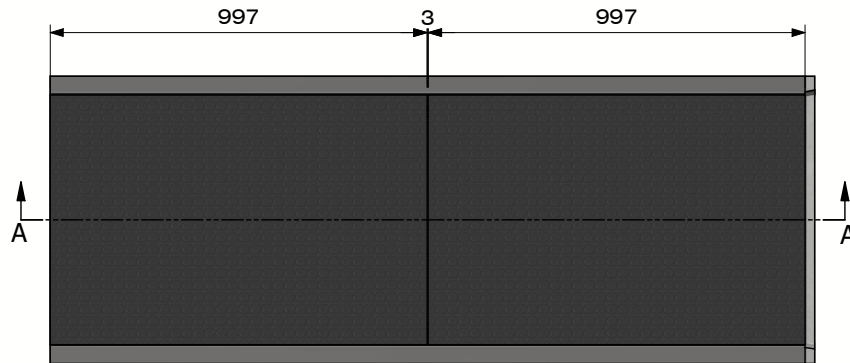

Zicht B

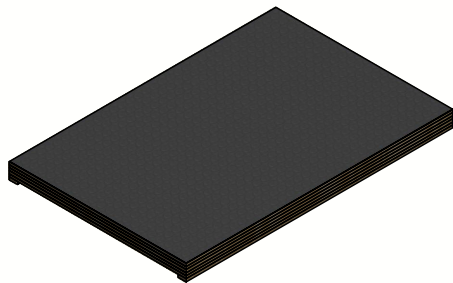

B125: Multiplex
DELTA-T600D1000IH060

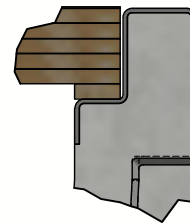



Detail C



B.P.M.N. SA
 Chaussée de namur , B-5150 Floriffoux

Project :	Technische fiche		
Art. nr. :	DELTA-T6003002000G060		
REV. nr. :	0	REV. Datum :	8/03/2021

DELTA-T GOOT 600x300
SERIE G060 TYPE I

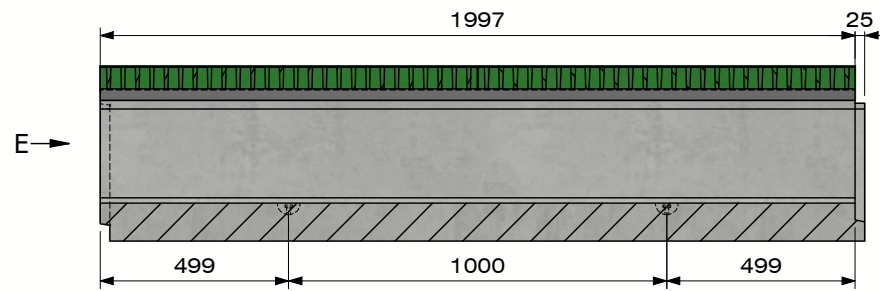

Sectie D-D
 (Schaal 1 : 20)

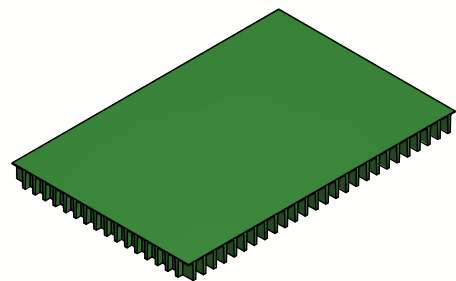
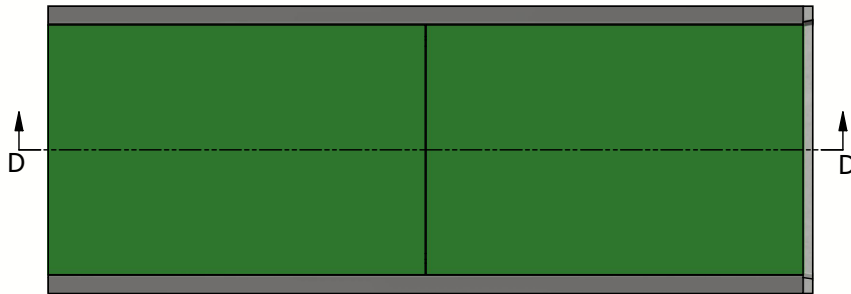

C250: Kunststof
 DELTA-T600D1000IP060

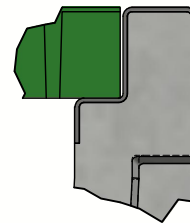

Detail F

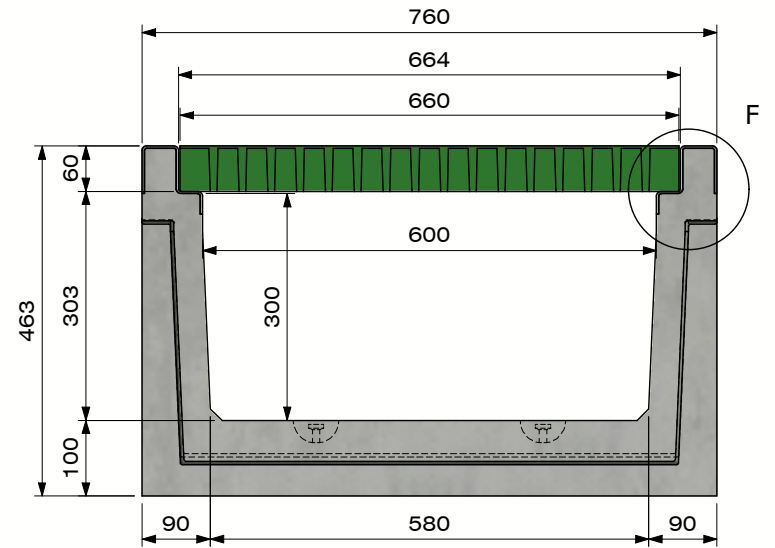

Zicht E



B.P.M.N. SA
 Chaussée de namur , B-5150 Floriffoux

Project : Technische fiche	
Art. nr. : DELTA-T6003002000G060	
REV. nr. : 0	REV. Datum : 8/03/2021

