

DELTA-U GOOT 300-250 SERIE B000 TYPE I

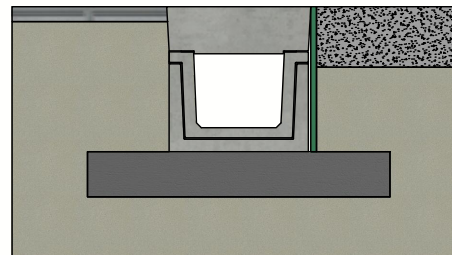

Principe type I
(Raadpleeg de plaatsingsvoorshriften)

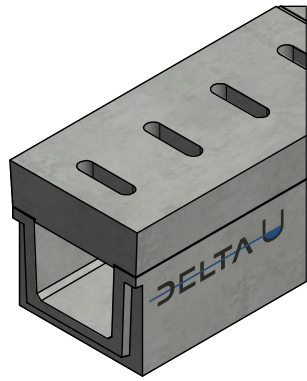
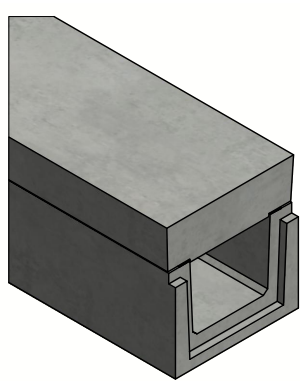

Belastingsklasse:	D400 cf EN1433
Instroomoppervlak cm ² / lm:	N/A
Sleufprofieltype:	N/A
Randen:	beton
Sectie stroomprofiel cm ² :	3600
Betonsterkteklasse:	C60/75
Omgevingsklassen:	XD3-XF4-XC4-XA3
Duurzaamheid:	W+R
Werkende lengte:	2000
Helling stroomprofiel:	0
Helling bovenvlak:	N/A
Verbinding:	T/G tand/groef
Hijsvoorziening:	4 x DH 1,3T
Plaatsingsvoorschrift:	volgens opgave producent
Normering:	conform EN1434
Gewicht:	736 Kg

DELTA U

B.P.M.N. SA
Chaussée de namur , B-5150 Floriffoux

Project :	Technische fiche	
Art. nr. :	DELTA-U3002502000B000D	
REV. nr. :	0	REV. Datum : 7/07/2020



DELTA-U GOOT 300-250 SERIE B000 TYPE I

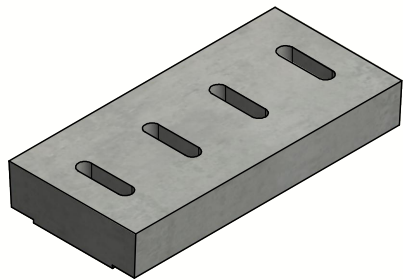
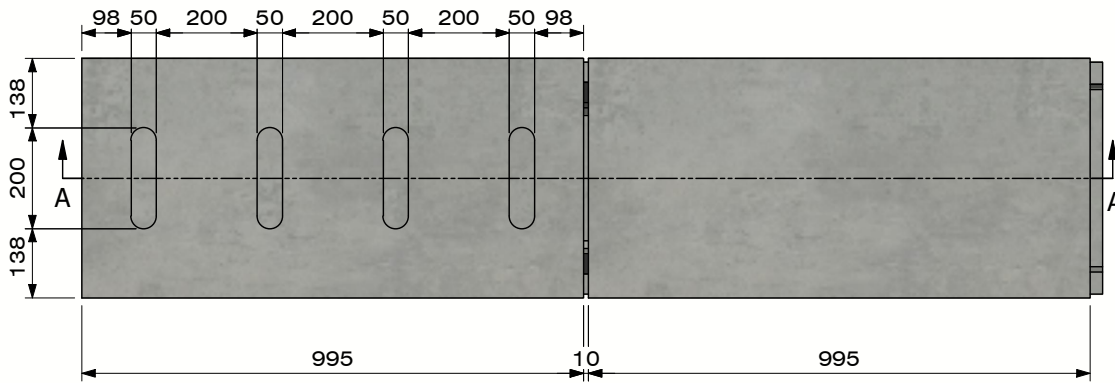
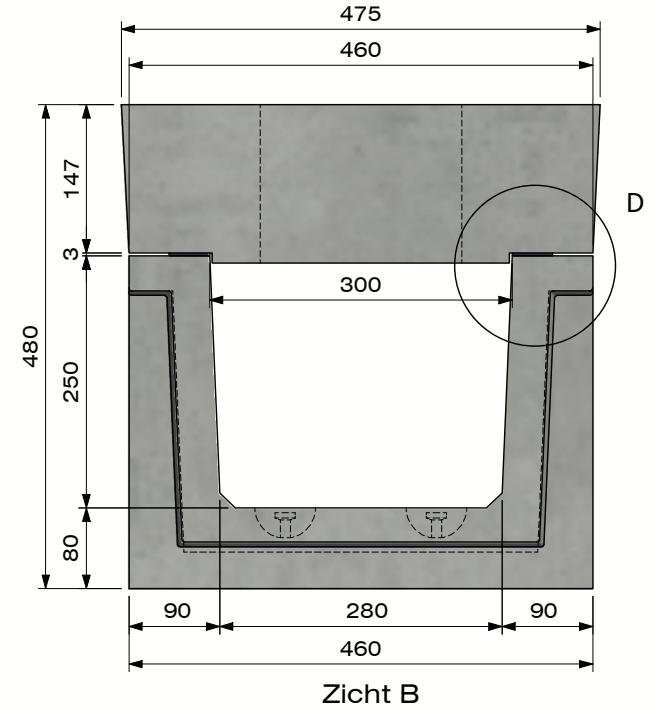
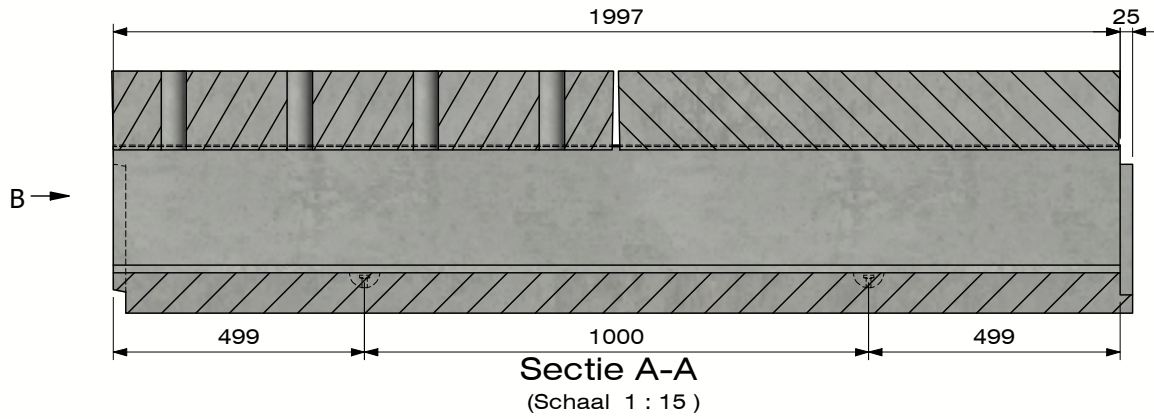

Dekplaat met openingen

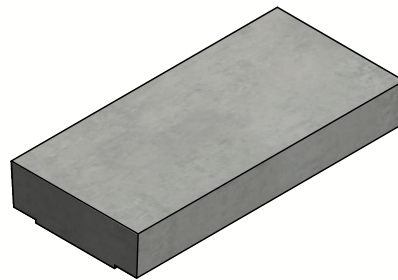

Dekplaat zonder openingen

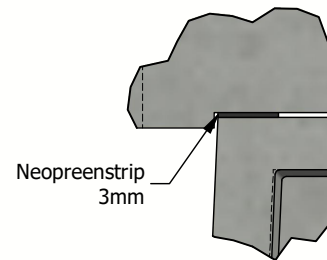

Detail D



B.P.M.N. SA
Chaussée de namur , B-5150 Floriffoux

Project :	Technische fiche		
Art. nr. :	DELTA-U3002502000B000D		
REV. nr. :	0	REV. Datum :	7/07/2020

