

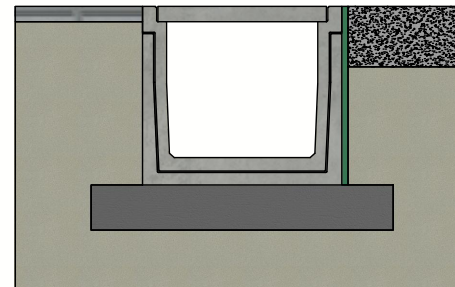

DELTA-U GOOT 500x450 SERIE B050 TYPE I

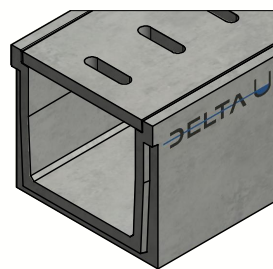

Belastingsklasse:	A15 cf EN1433
Instroomoppervlak cm ² / lm:	N/A
Sleufprofieltype:	N/A
Randen:	beton
Sectie stroomprofiel cm ² :	2250
Betonsterkteklasse:	C60/75
Omgevingsklassen:	XD3-XF4-XC4-XA3
Duurzaamheid:	W+R
Werkende lengte:	2000
Helling stroomprofiel:	0
Helling bovenzvlak:	N/A
Verbinding:	T/G tand/groef
Hijsvoorziening:	4 x DH 1,3T
Plaatsingsvoorschrift:	volgens opgave producent
Normering:	conform EN1433
Gewicht:	823 Kg

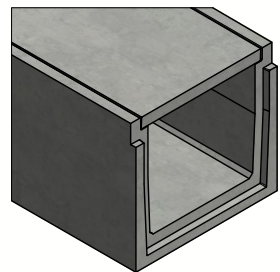



Principe type I
(Raadpleeg de plaatsingsvoorschriften)



B.P.M.N. SA
Chaussée de namur , B-5150 Floriffoux

Project :	Technische fiche	
Art. nr. :	DELTA-U5004502000B050A	
REV. nr. :	0	REV. Datum : 11/08/2020

DELTA-U GOOT 500x450 SERIE B050 TYPE I

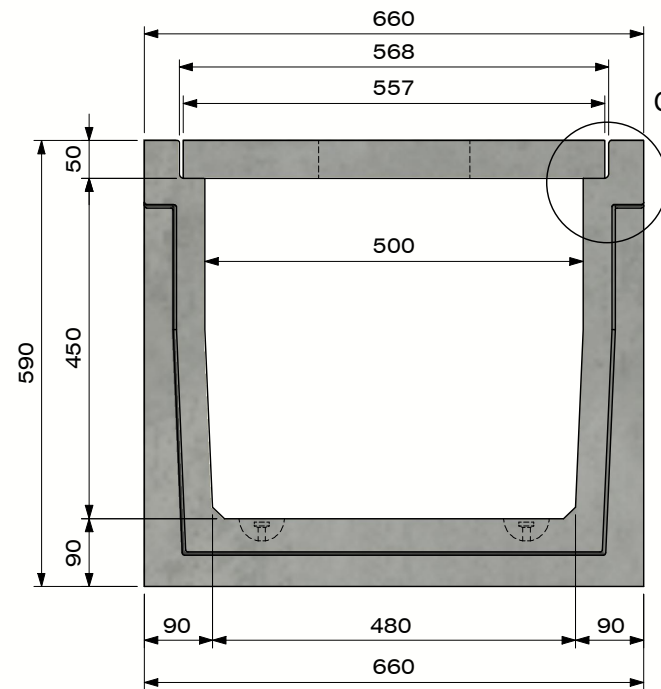
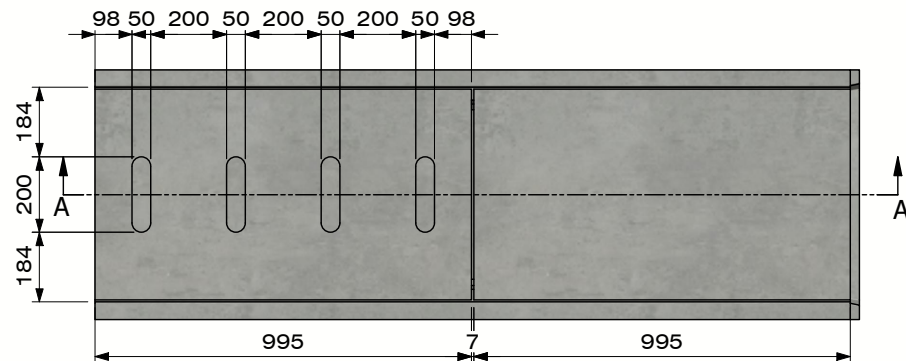
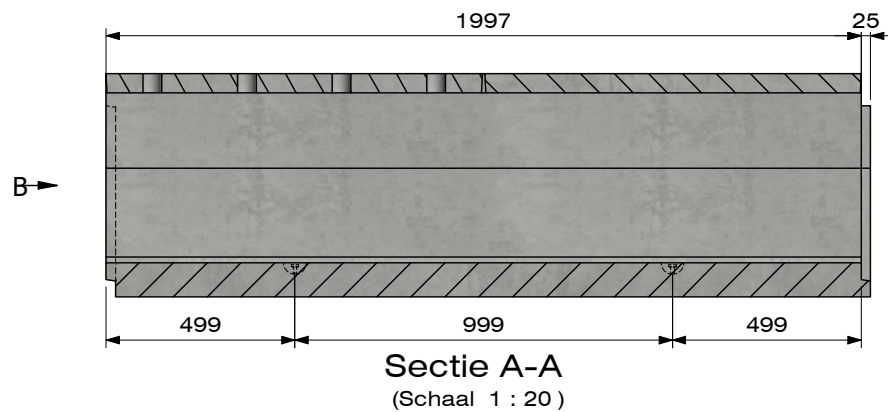

Zicht B

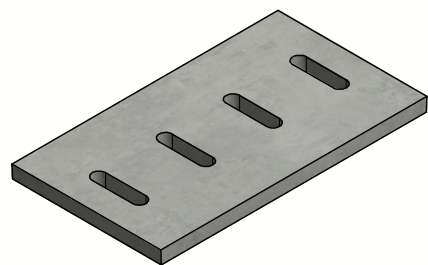

Dekplaat
met openingen

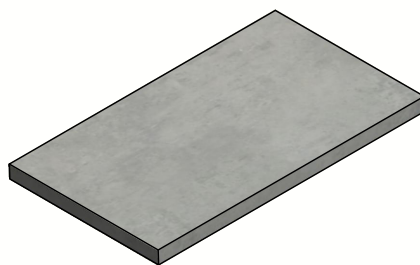

Dekplaat
zonder openingen

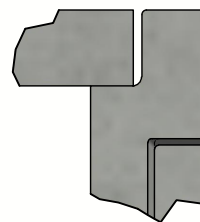

Detail C



B.P.M.N. SA
Chaussée de namur , B-5150 Floriffoux

Project :	Technische fiche		
Art. nr. :	DELTA-U5004502000B050A		
REV. nr. :	0	REV. Datum :	11/08/2020

