

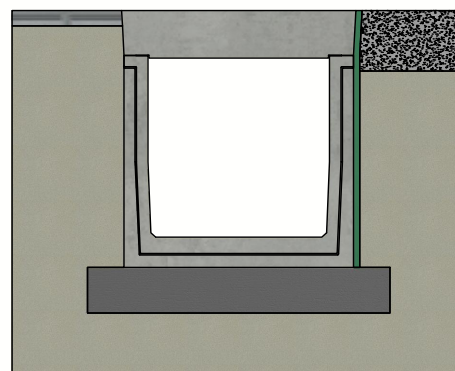

# DELTA-U GOOT 600x600 SERIE B000 TYPE I

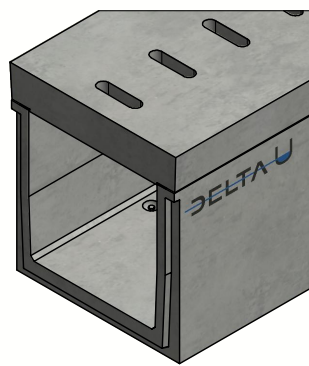

Principe type I  
(Raadpleeg de plaatsingsvoorschriften)

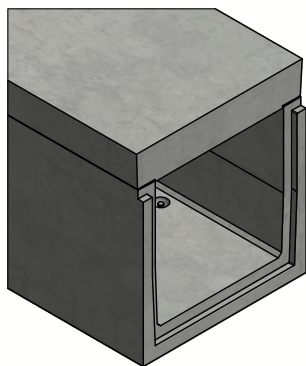



Belastingsklasse:	D400 cf EN1433
Instroomoppervlak cm <sup>2</sup> / lm:	N/A
Sleufprofieltype:	N/A
Randen:	geen
Sectie stroomprofiel cm <sup>2</sup> :	3600
Betonsterkteklasse:	C60/75
Omgevingsklassen:	XD3-XF4-XC4-XA3
Duurzaamheid:	W+R
Werkende lengte:	2000
Helling stroomprofiel:	0
Helling bovenvlak:	N/A
Verbinding:	T/G tand/groef
Hijsvoorziening:	4 x DH 1,3T
Plaatsingsvoorschrift:	volgens opgave producent
Normering:	getest volgens EN1433
Gewicht:	1473 Kg



B.P.M.N. SA  
Chaussée de namur , B-5150 Floriffoux

Project :	<b>Technische fiche</b>	
Art. nr. :	DELTA-U6006002000B000D	
REV. nr. :	0	REV. Datum : 4/08/2020

# DELTA-U GOOT 600x600 SERIE B000 TYPE I

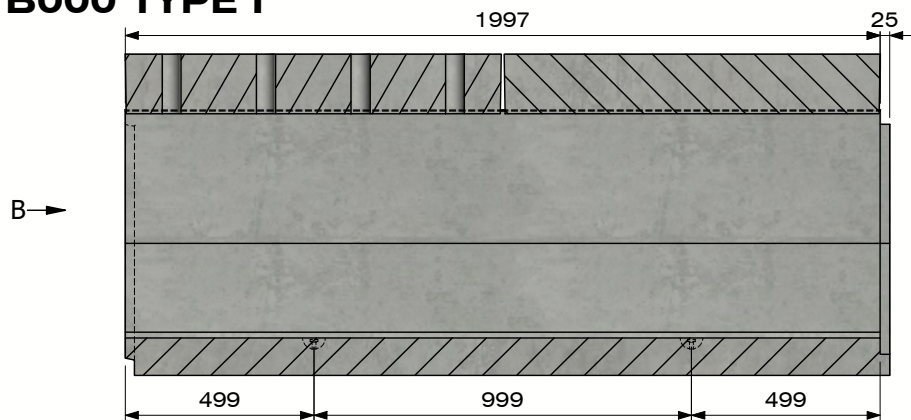

Sectie A-A  
(Schaal 1 : 20)

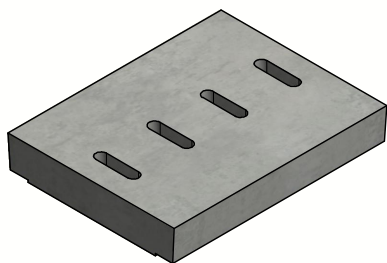
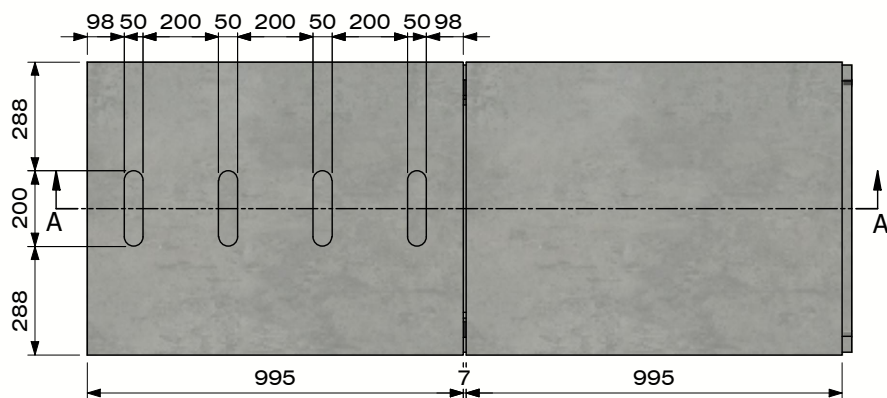

Dekplaat  
met openingen

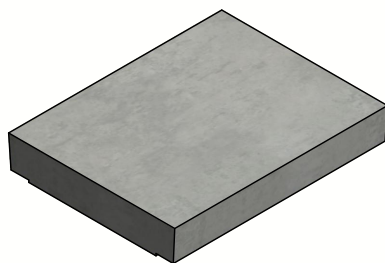

Dekplaat  
zonder openingen

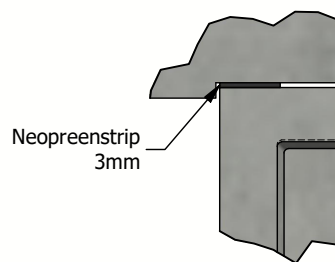

Detail D

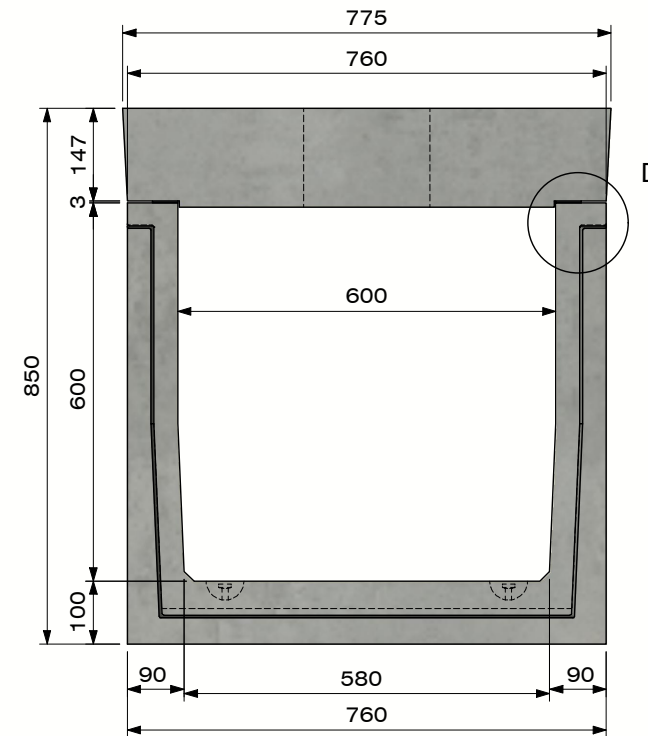

Zicht B



B.P.M.N. SA  
Chaussée de namur , B-5150 Floriffoux

Project :	<b>Technische fiche</b>		
Art. nr. :	DELTA-U6006002000B000D		
REV. nr. :	0	REV. Datum :	4/08/2020

