

DELTA-U GOOT 600x600 SERIE B150 TYPE I

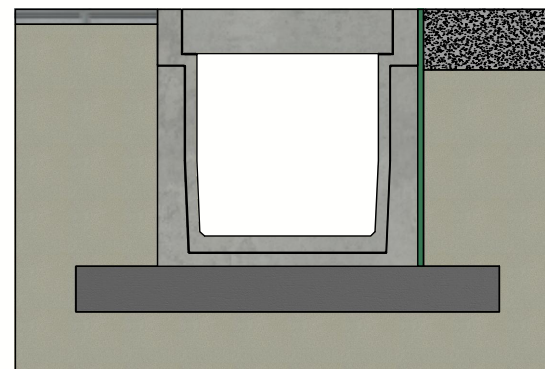

Belastingsklasse:	D400 cf EN1433
Instroomoppervlak cm ² / lm:	N/A
Sleufprofieltype:	N/A
Randen:	beton
Sectie stroomprofiel cm ² :	3600
Betonsterkteklasse:	C60/75
Omgevingsklassen:	XD3-XF4-XC4-XA3
Duurzaamheid:	W+R
Werkende lengte:	2000
Helling stroomprofiel:	0
Helling bovenvlak:	N/A
Verbinding:	T/G tand/groef
Hijsvoorziening:	4 x DH 1,3T
Plaatsingsvoorschrift:	volgens opgave producent
Normering:	getest volgens EN1433
Gewicht:	1863 Kg

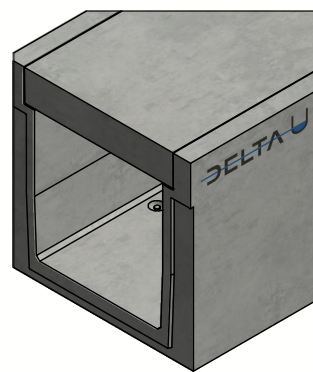
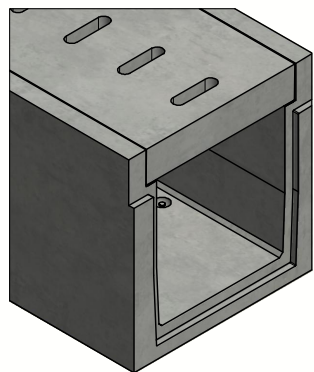

Principe type I
(Raadpleeg de plaatsingsvoorschriften)

DELTA U

B.P.M.N. SA
Chaussée de namur , B-5150 Floriffoux

Project :	Technische fiche	
Art. nr. :	DELTA-U6006002000B150D	
REV. nr. :	0	REV. Datum : 13/08/2020



DELTA-U GOOT 600x600 SERIE B150 TYPE I

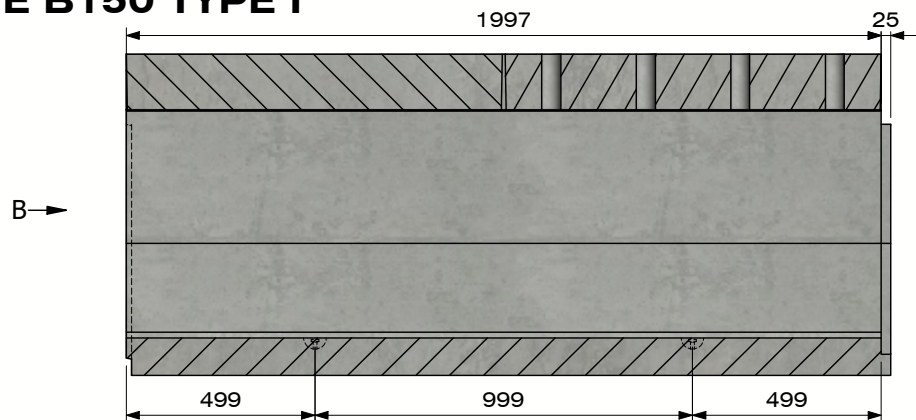

Sectie A-A
(Schaal 1 : 20)

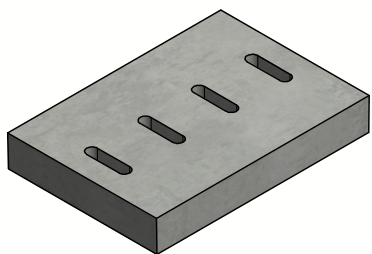
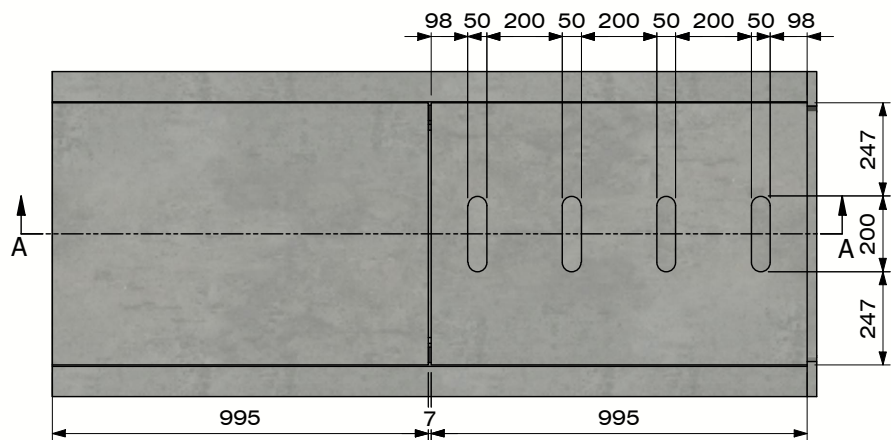

Dekplaat
met openingen

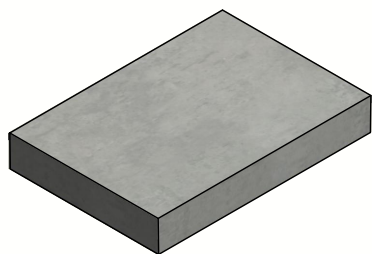

Dekplaat
zonder openingen

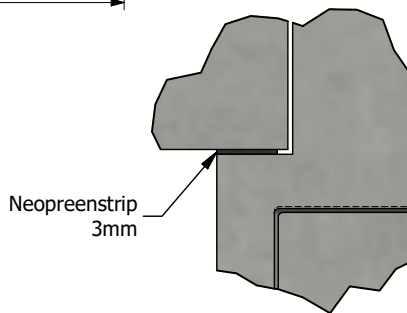

Detail D

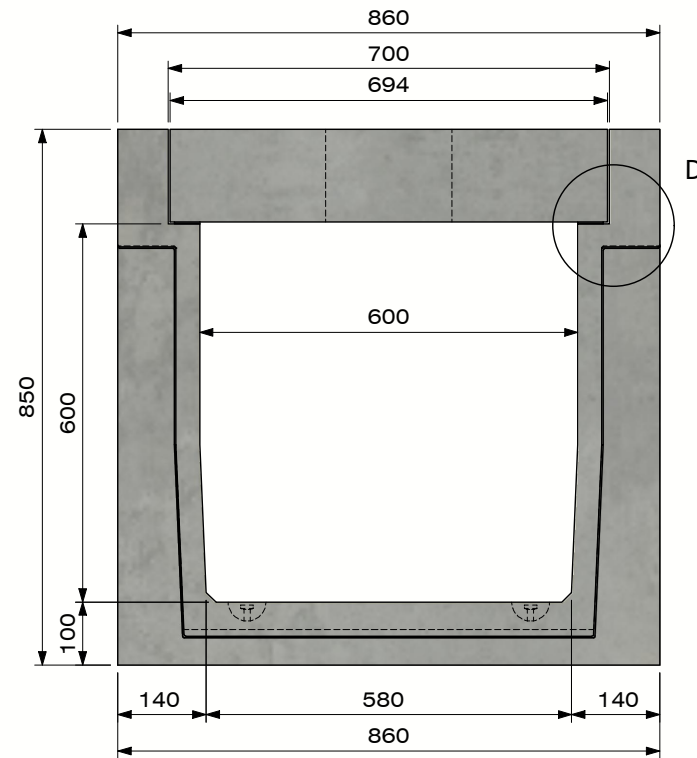

Zicht B



B.P.M.N. SA
Chaussée de namur , B-5150 Floriffoux

Project :	Technische fiche		
Art. nr. :	DELTA-U6006002000B150D		
REV. nr. :	0	REV. Datum :	13/08/2020

