

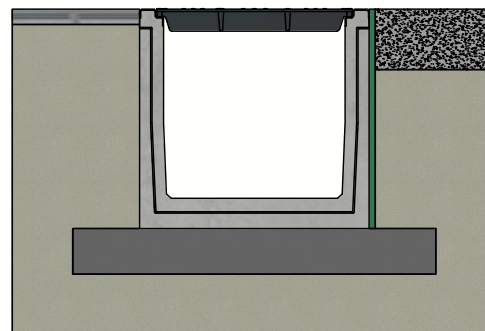

DELTA-U ROOSTERGROOT 600x600 SERIE G025 TYPE I

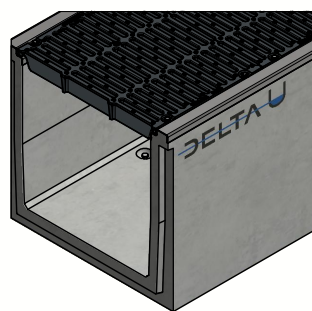

Principe type I
(Raadpleeg de plaatsingsvoorschriften)

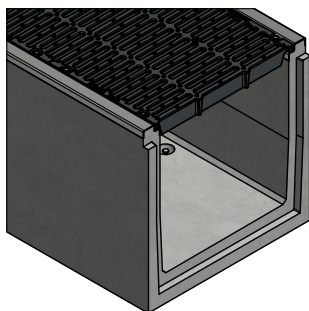



Belastingsklasse:	D400-F900 of EN1433
Instroomoppervlak cm ² / lm:	N/A
Sleufprofieltype:	N/A
Randen:	staal, galva
Sectie stroomprofiel cm ² :	3600
Betonsterkteklasse:	C60/75
Omgevingsklassen:	XD3-XF4-XC4-XA3
Duurzaamheid:	W+R
Werkende lengte:	2000
Helling stroomprofiel:	0
Helling bovenvlak:	N/A
Verbinding:	T/G tand/groef
Hijsvoorziening:	4 x DH 1,3T
Plaatsingsvoorschrift:	volgens opgave producent
Normering:	conform EN1433
Gewicht:	1156 Kg



B.P.M.N. SA
Chaussée de namur , B-5150 Floriffoux

Project :	Technische fiche	
Art. nr. :	DELTA-U6006002000G025	
REV. nr. :	0	REV. Datum : 13/08/2020

DELTA-U ROOSTERGROOT 600x600 SERIE G025 TYPE I

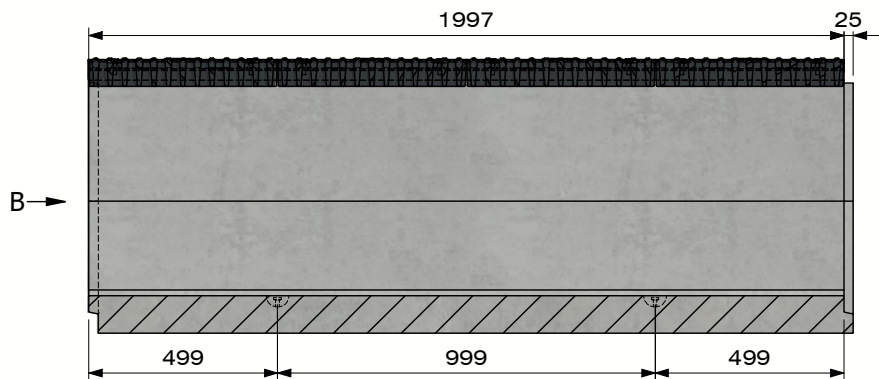

Sectie A-A
(Schaal 1 : 20)

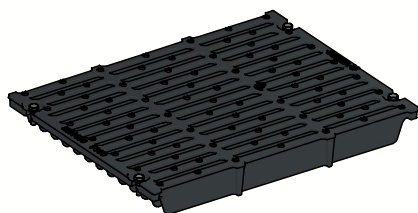
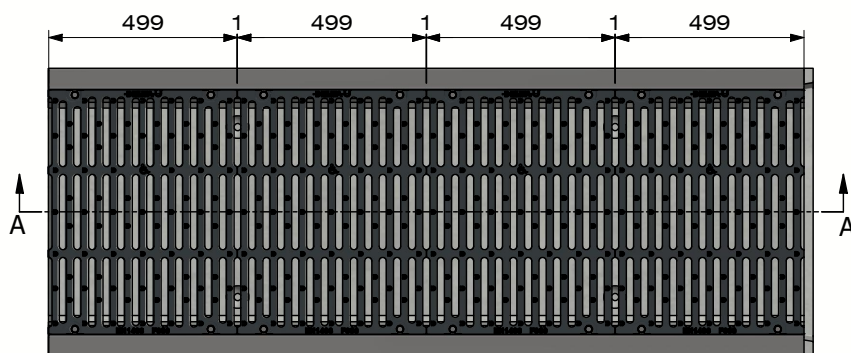

D400 : DELTA-U600D500IS025D-DR
F900 : DELTA-U600D500IS025F-DR

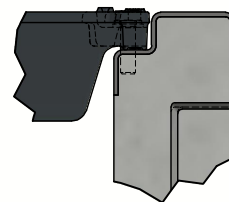

Detail C

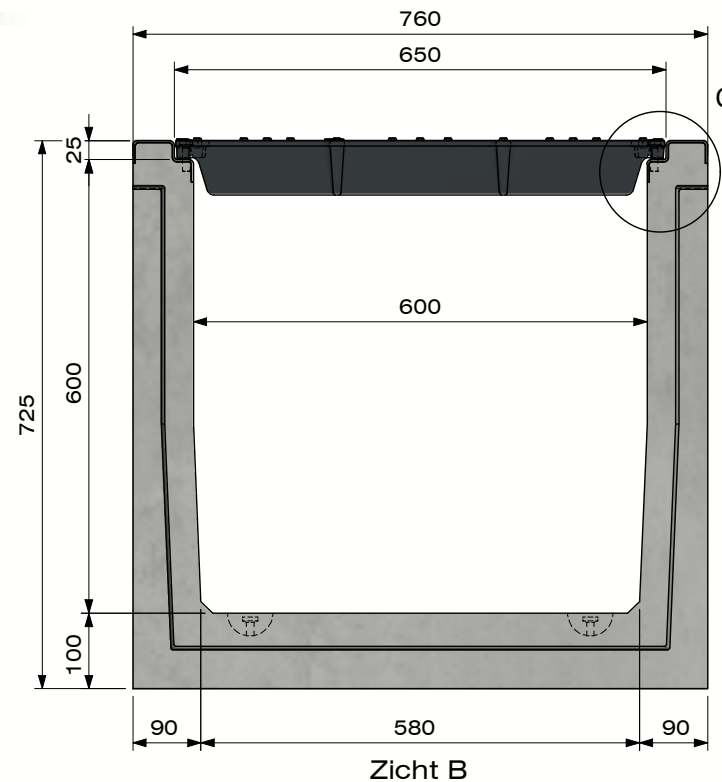

Zicht B



B.P.M.N. SA
Chaussée de namur , B-5150 Floriffoux

Project :	Technische fiche		
Art. nr. :	DELTA-U6006002000G025		
REV. nr. :	0	REV. Datum :	13/08/2020

