

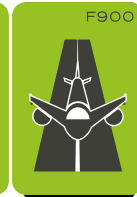

DELTA-U zandvangelement type 1

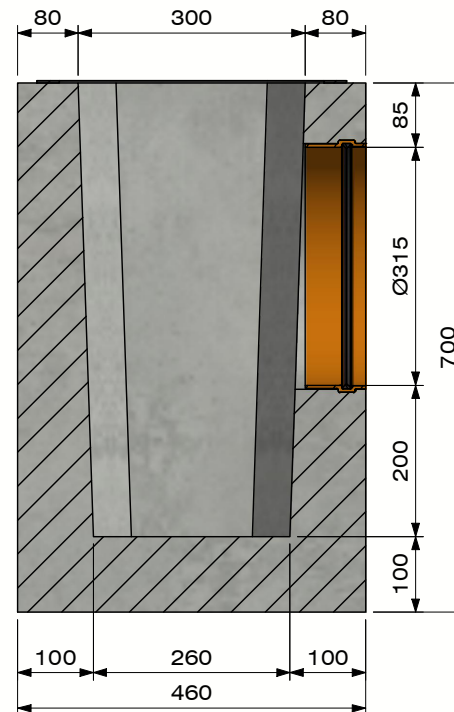

Belastingsklasse:	F900 cf EN1433
Instroomoppervlak cm ² / lm:	N/A
Sleufprofieltype:	N/A
Randen:	N/A
Sectie stroomprofiel cm ² :	N/A
Betonsterkteklasse:	C60/75
Omgevingsklassen:	XD3-XF4-XC4-XA3
Duurzaamheid:	W+R
Werkende lengte:	960
Helling stroomprofiel:	N/A
Helling bovenvlak:	N/A
Verbinding:	N/A
Hijsvoorziening:	4 x DH 1,3T
Plaatsingsvoorschrift:	volgens opgave producent
Normering:	conform EN1433
Gewicht:	433 Kg

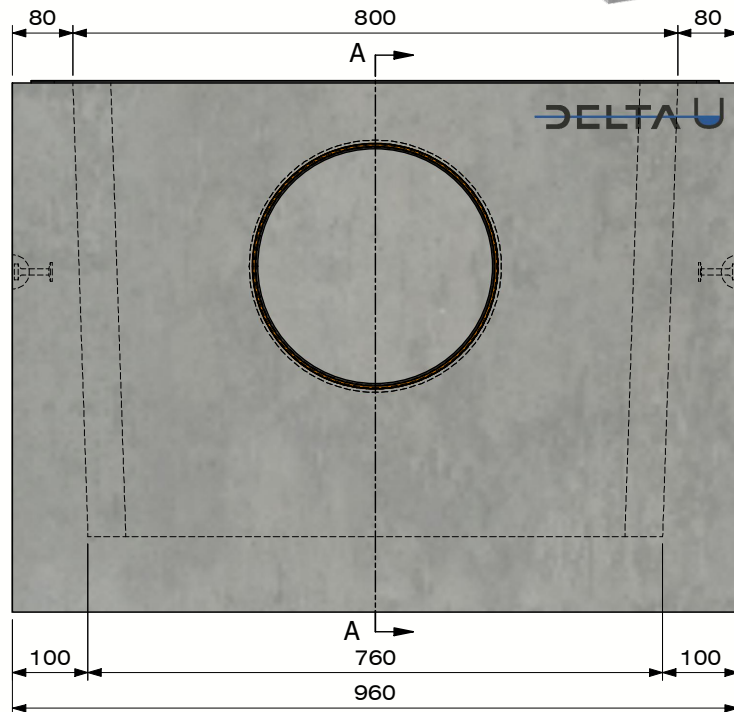



Sectie A-A
(Schaal 1 : 10)





B.P.M.N. SA
Chaussée de namur 2 , B-5150 Floriffoux

Project : Accessoires & supplementen	
Art. nr. : DELTA-UZVE-Type 1	
REV. nr. : 0	REV. Datum : 25/01/2021

BRL 5211
ELEMENTEN VOOR
LIJNAFWATERING

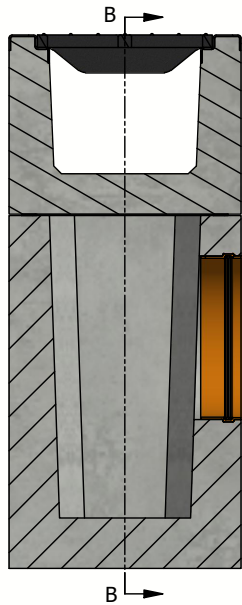

Sectie : A-A
(Schaal : 1 : 15)

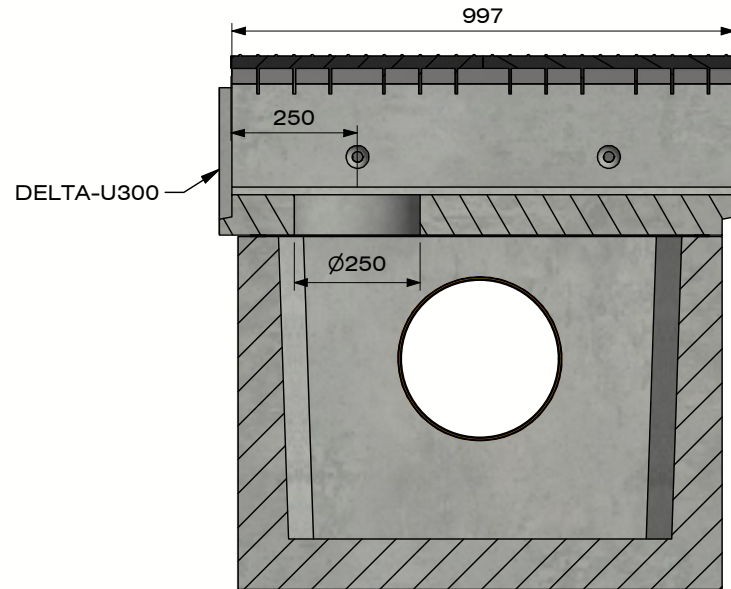

Sectie : B-B
(Schaal : 1 : 15)

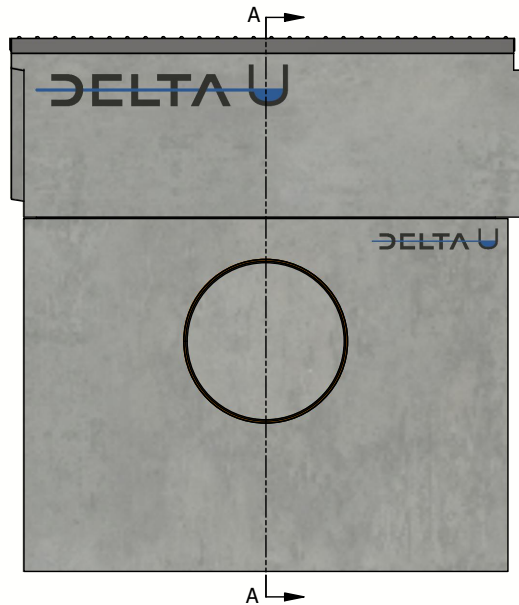

B.P.M.N. SA Chaussée de namur 2 , B-5150 Floriffoux	
Project :	Accessoires & supplementen
Art. nr. :	DELTA-UZVE-Type 1
REV. nr. :	0
REV. Datum :	25/01/2021
<small>BRL S211 ELEMENTEN VOOR LUNAFWATERING</small>	

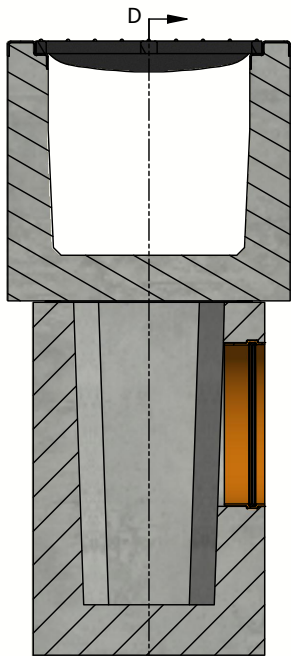

Sectie : C-C
(Schaal : 1 : 15)

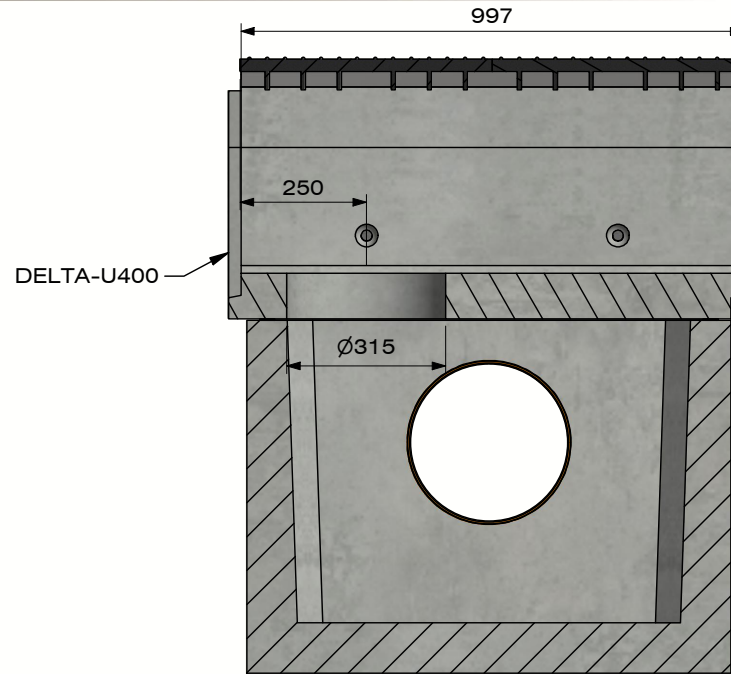

Sectie : D-D
(Schaal : 1 : 15)

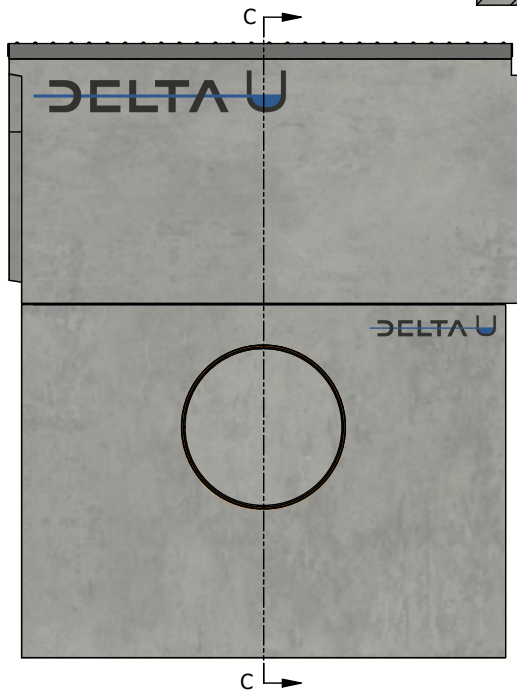

B.P.M.N. SA Chaussée de namur 2 , B-5150 Floriffoux	
Project :	Accessoires & supplementen
Art. nr. :	DELTA-UZVE-Type 1
REV. nr. :	0
REV. Datum :	25/01/2021