

DELTA-O verholen goot DN300 - serie SB - Type I

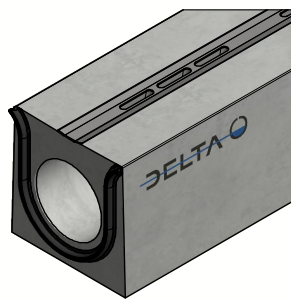

Drukverbinding met EPDM
rubberdichting

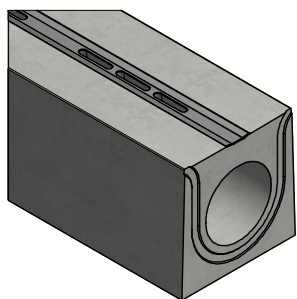
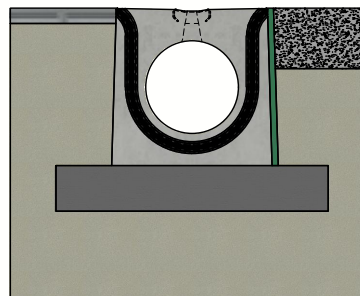

Principe type I
(Raadpleeg de plaatsingsvoorschriften)



Belastingsklasse:	D400-E600-F900 cf EN1433
Instroomoppervlak cm ² / lm:	286
Sleufprofieltype:	staal
Randen:	beton
Sectie stroomprofiel cm ² :	726
Betonsterkteklasse:	C60/75
Omgevingsklassen:	XD3-XF4-XC4-XA3
Duurzaamheid:	W+R
Werkende lengte:	4000
Helling stroomprofiel:	0
Helling bovenvlak:	centrisch 1%
Verbinding:	drukverbinding
Hijsvoorziening:	2 x hijsleutel
Plaatsingsvoorschrift:	volgens opgave producent
Normering:	conform EN1433
Gewicht:	1883 Kg



B.P.M.N. SA
Chaussée de namur 2, B-5150 Floriffoux

Project :	Technische fiche	
Art. nr. :	DELTA-O3004000SB	
REV. nr. :	0	REV. Datum : 16/12/2020



DELTA-O verholen goot DN300 - serie SB - Type I

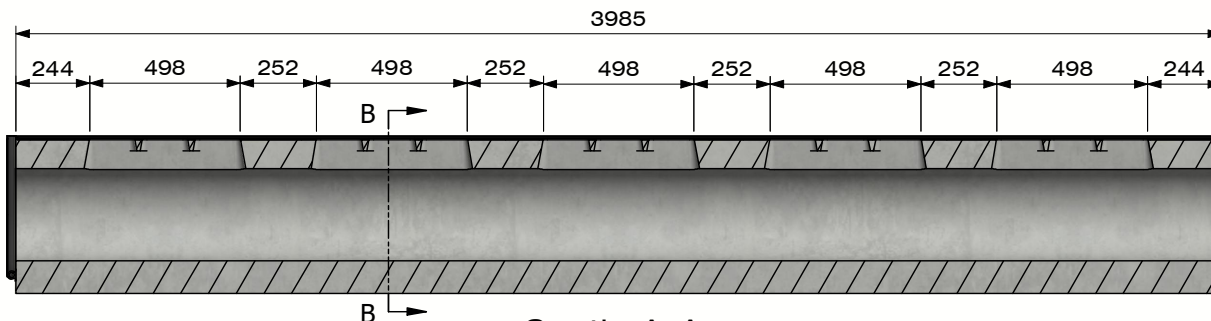

Sectie A-A
(Schaal 1 : 25)

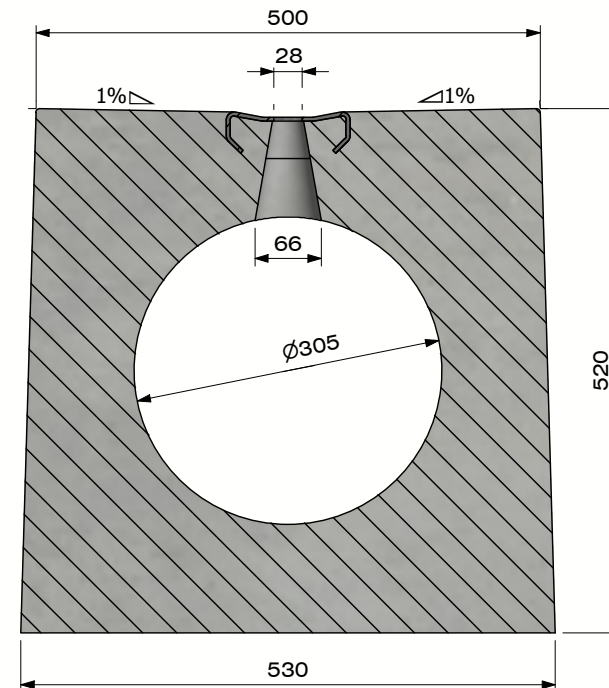

Sectie B-B
(Schaal 1 : 7.5)

- Optie GIR :

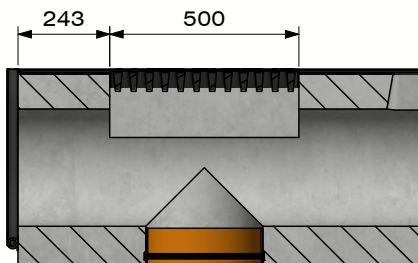

Geïntegreerd inspectierooster
- D400-E600-F900
- Vergrendelbaar
Optioneel bodemaafloop



B.P.M.N. SA
Chaussée de namur 2, B-5150 Floriffoux

Project :	Technische fiche		
Art. nr. :	DELTA-O3004000SB		
REV. nr. :	0	REV. Datum :	16/12/2020