

DELTA-U ROOSTERGROOT 400x600 SERIE G025 TYPE I

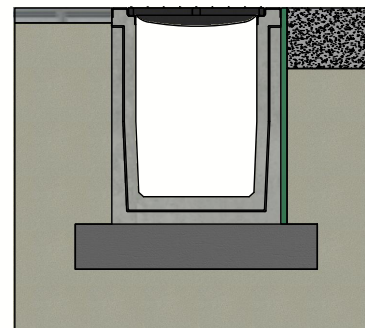

Belastingsklasse:	D400-F900 of EN1433
Instroomoppervlak cm ² / lm:	N/A
Sleufprofieltype:	N/A
Randen:	staal, galva
Sectie stroomprofiel cm ² :	2400
Betonsterkteklasse:	C60/75
Omgevingsklassen:	XD3-XF4-XC4-XA3
Duurzaamheid:	W+R
Werkende lengte:	3000
Helling stroomprofiel:	0
Helling bovenzijde:	N/A
Verbinding:	T/G tand/groef
Hijsvoorziening:	4 x DH 1,3T
Plaatsingsvoorschrift:	volgens opgave producent
Normering:	conform EN1433
Gewicht:	1364 Kg

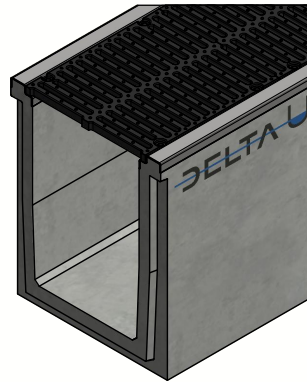
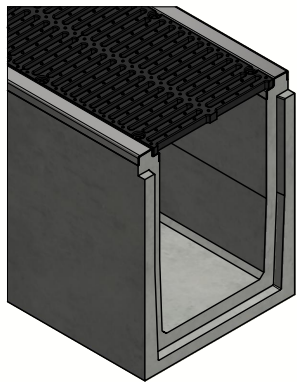

Principe type I
(Raadpleeg de plaatsingsvoorschriften)

DELTA U

B.P.M.N. SA
Chaussée de namur , B-5150 Floriffoux

Project :	Technische fiche	
Art. nr. :	DELTA-U4006003000G025	
REV. nr. :	0	REV. Datum : 11/08/2020



DELTA-U ROOSTERGROOT 400x600 SERIE G025 TYPE I

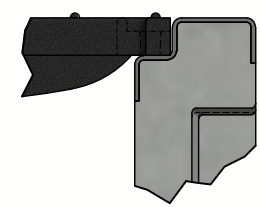
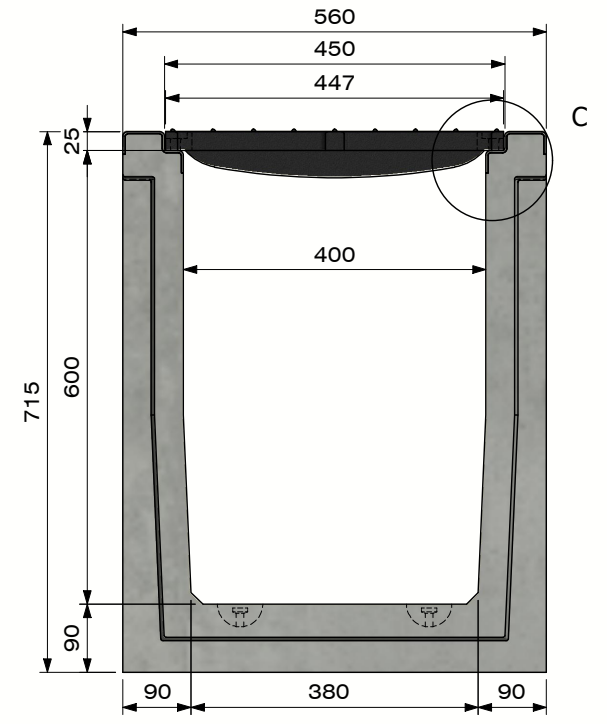
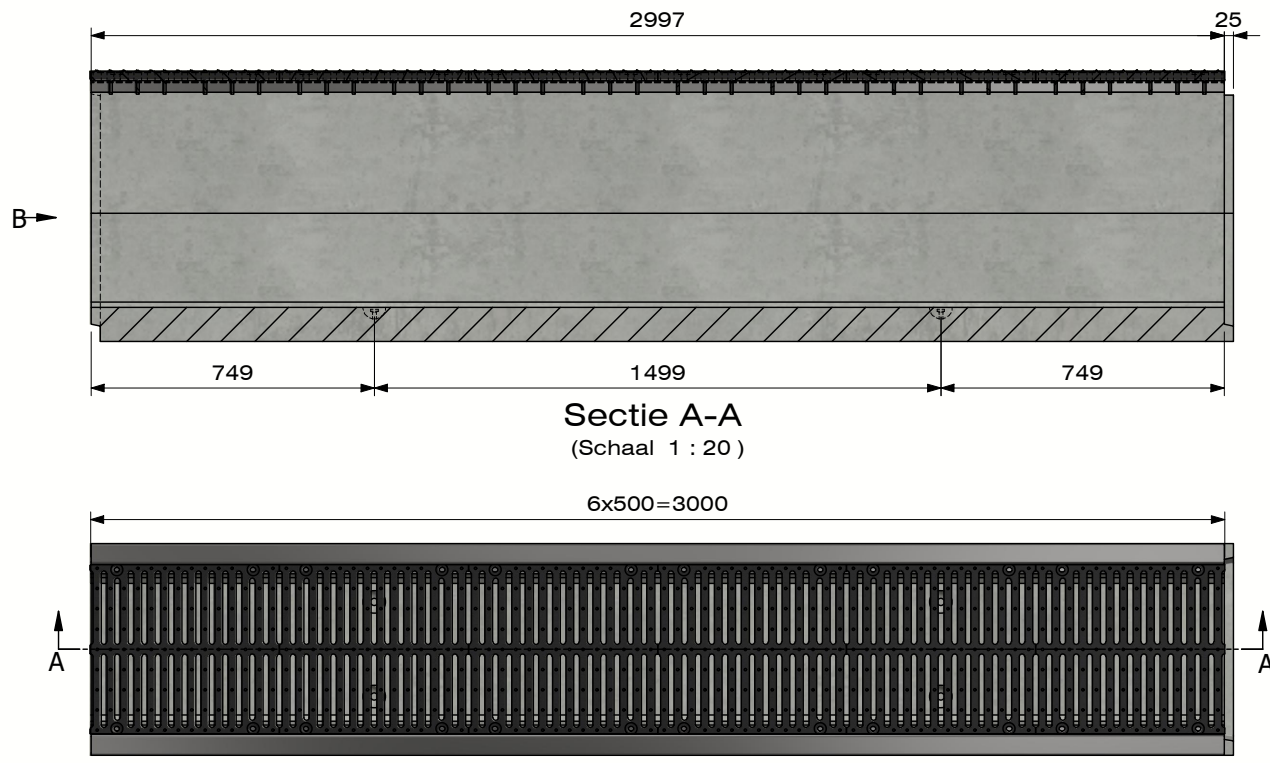

D400 : DELTA-U400D500IS025D-DR
F900 : DELTA-U400D500IS025F-DR

Detail C



B.P.M.N. SA
Chaussée de namur , B-5150 Floriffoux

Project :	Technische fiche	
Art. nr. :	DELTA-U4006003000G025	
REV. nr. :	0	REV. Datum : 11/08/2020

